

बिहार सरकार
नगर विकास एवं आवास विभाग

प्रेषक,

विशेष सचिव-सह-निदेशक,
नगर विकास एवं आवास विभाग।

सेवा में,

नगर आयुक्त,
नगर निगम, पटना।

पटना, दिनांक-28/9/18

विषय:- पटना नगर निगम क्षेत्रान्तर्गत हड़ताली मोड़ से बोरिंग केनाल रोड होते हुए राजापुर पुल तक के स्थल पर प्रस्तावित वेंडिंग जोन निर्माण की प्रशासनिक स्वीकृति।

प्रसंग:- आपका पत्रांक-6707 दिनांक-09.08.2018

महाशय,

निदेशानुसार उपर्युक्त विषयक प्रसंगाधीन पत्र के संदर्भ में कहना है कि आपके द्वारा हड़ताली मोड़ से बोरिंग केनाल रोड होते हुए राजापुर पुल तक वेंडिंग जोन के निर्माण का प्रस्ताव प्राप्त हुआ है। DAY-NULM योजनान्तर्गत वर्णित स्थल पर वेंडिंग जोन निर्माण योजना के क्रियान्वयन हेतु प्राक्कलित राशि ₹0 7,04,40,000/- (रुपये सात करोड़ चार लाख चालीस हजार मात्र) के व्यय की प्रशासनिक स्वीकृति प्रदान की जाती है।

2. योजना के कार्यान्वयन हेतु प्रथम किस्त की राशि ₹0 3,00,00,000.00 (रुपये तीन करोड़ मात्र) PFMS/RTGS के माध्यम से उपलब्ध कराया जायेगा। उपयोगिता प्रमाण पत्र प्राप्त होने पर अंतिम किस्त की अवशेष राशि उपलब्ध कराया जा सकेगा।

3. योजना के कार्यान्वयन हेतु सभी आवश्यक एवं वांछित औपचारिकता पूर्ण करते हुए छह माह के अंदर नगर निगम, पटना द्वारा निर्माण कार्य पूर्ण कराया जायेगा।

4. कार्य का अनुश्रवण नगर आयुक्त, नगर निगम, पटना/कार्यपालक अभियंता/कनीय अभियंता, डुडा, पटना एवं PMC के प्रतिनिधि द्वारा किया जायेगा।

5. निर्माण कार्य में मानक गुणवत्ता का पालन अवश्य किया जायेगा।

6. कार्य समाप्ति के पश्चात व्यय की गयी राशि का उपयोगिता प्रमाण पत्र एवं कार्यपूर्णता प्रमाण पत्र एक माह के अंदर अवश्य उपलब्ध कराया जायेगा।

7. योजना के प्रस्ताव पर सक्षम प्राधिकार का तकनीकी एवं प्रशासनिक अनुमोदन प्राप्त है।

अनुलग्नक-प्राक्कलन की संशोधित मूल प्रति।

विश्वासभाजन,

विशेष सचिव-सह-निदेशक,
नगर विकास एवं आवास विभाग।

पटना नगर निगम

پٹنہ میونسپل کارپوریشن

PATNA MUNICIPAL CORPORATION



Letter No. / पत्रांक: 6707...

Date / दिनांक: 09-08-2018

Patna Municipal Corporation

Date: 09-08-2018



2018206707



http://pmc.bihar.gov.in

1641
9-8-18

S.S(SK)

सेवा में,

प्रधान सचिव,
नगर विकास एवं आवास विभाग,
बिहार, पटना।



बोरिंग रोड अवस्थित हड़ताली मोड़ से राजापुर पुल तक वेंडिंग जोन के निर्माण संबंधी परियोजना प्रतिवेदन पर प्रशासनिक स्वीकृति प्रदान करने के संबंध में।

उपर्युक्त विषय के संबंध में समर्पित कहना है कि पटना शहर के अन्तर्गत सड़कों पर जाम की समस्या से निपटने के लिये तथा संपूर्ण शहर के बाजारों को व्यवस्थित बनाये जाने के लिये वेंडिंग जोन का निर्माण आवश्यक है। इस क्रम में बोरिंग रोड अवस्थित सड़कों को जाम से मुक्ति दिलाने एवं फुटपाथ विक्रेताओं की बेतरतीब दुकानों को सुव्यवस्थित बनाने के उद्देश्य से हड़ताली मोड़ से लेकर राजापुर पुल तक वेंडिंग जोन का परियोजना प्रतिवेदन तैयार कराया गया है। इस वेंडिंग जोन में हर प्रकार के सब्जी, मीट-मछली तथा विविध प्रकार के फुटपाथ विक्रेताओं को जगह दी गयी है, जिनका कुल प्रस्तावित संख्या 564 है। इस वेंडिंग जोन के निर्माण पर कुल रू० 641.35 लाख का खर्च अनुमानित है, जिसका परियोजना प्रतिवेदन प्रशासनिक स्वीकृति के लिये समर्पित किया जा रहा है। ज्ञातव्य है कि उक्त क्षेत्र में वेंडिंग जोन बनाने का निर्णय टाउन वेंडिंग कमिटी के द्वारा स्वीकृत किया जा चुका है। इसी स्थान पर दूसरे चरण में आवश्यक संख्या में पार्किंग का परियोजना प्रतिवेदन भी अलग से समर्पित किया जायेगा।

- अतः बोरिंग रोड अवस्थित हड़ताली मोड़ से राजापुर पुल तक प्रस्तावित वेंडिंग जोन के परियोजना प्रतिवेदन की कुल राशि रू० 641.35 लाख पर प्रशासनिक स्वीकृति प्रदान करने तत्संबंधी राशि उपलब्ध कराने की कृपा की जाय।

अनु०- परियोजना प्रतिवेदन (दो प्रति)

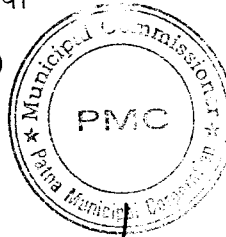

विश्वासभाजन

नगर आयुक्त
पटना नगर निगम

1532
PMC-MULM
14-Aug-18

10 AUG 2018
8854

S.O.-4

Su. Rawat
14/8

341

Date – 03-08-2018

**VENDING ZONE
BORING CANAL ROAD
HARTALI MORE TO RAJAPUR PUL**

**PHASE-I
TOTAL COST =Rs 641.35 Lacs**



**Submitted to
PATNA MUNICIPAL CORPORATION
PATNA**

100 - B, Patliputra colony . Opp P & M Mall,
Near Notre Dame Academy, Patna 800013
Tel / Fa x: 2267175 / 2275624
Email: contact@kapoors.biz . Web: WWW.Kapoors.Biz

k&a

Kapoor and associates
ARCHITECTURE | INTERIOR DESIGN | URBAN DESIGN

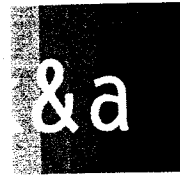

July 18th, 2018
Revised: August 1st, 2018

REF:PMC/0014/2018

VENDING ZONE-BORING CANAL ROAD
HARTALI MORE TO RAJAPUR PUL

NUMBER OF HAWKERS AS / NASMI STUDY = 479
NUMBER OF HAWKERS ACCOMODATED AS / THIS SCHEME = 564

PHASE-I

1. The Central Median of the road is used, both for parking and for vendors.
2. The “vending zones” shall cater to the existing vendors. These zones shall be of different types, to cater to the different categories of vendors in this stretch.
3. The vending zones shall have Kota Stone Flooring which can be swept with cleaning machines.
4. The vending zones shall be of different types and categories, and shall cater to the specific needs of hawkers in the exact zone where they are located.
5. A typical vending zone shall have the following facilities / amenities:-
 - a) Tensile Structures for Hawkers
 - b) Benches & other Street Furniture
 - c) Area Lighting
 - d) One Water Point

The vending zones for Meat & Vegetable Vendors shall differently designed.

6. The entrance to the vending zone shall by a small ramp. Towards the road side, we have proposed M.S grills. The height of the vending zones is above the parking height. Benches, dustbins and decorative lamps have been provided. In some options standing tables have been given. Where fully grown shady trees are there, a round platform has been proposed around the trunk to facilitate customer seating.
7. The Meat Vending zone doesn't open on to the street but is a closed space accessible from inside only. Each Meat Shop has 2 zones, the open platform for selling and an enclosed space for cutting of meat. It shall be fully covered by a Tensile Structure.

8. The Vegetable Vending zone shall have open platforms facing inside covered by a tensile structure.
9. It may be noted that lighting is proposed only for the "Vending Zones" and not for the 'parking areas'.
10. In general, pavements are not proposed on the outskirts of the Vending Zones- these shall be on the other flank of the road, where the buildings / structures are located, and are not included in the scope of work.
11. The quantities given are tentative, and shall be finalized after the exact Total Station Survey is carried out.

It may be noted that we have provided extra shops / hawkers over and above the NASMI report. Details of the same are also attached in the report.

PHASE-II

After Phase- I is carried out, in Phase- II, the flooring of the parking area shall be done in Designer "Stamped" Concrete, which shall be aesthetically pleasing, strong and durable, and shall be able to be swept with cleaning machines. These can be "smart parking zones" and sensor based parking can be implemented.

351

K A P O O R A N D A S S O C I A T E S

Ravi Kapoor B.Arch, Chd, M.Arch, IIT-KGP, M.Arch & U.D Washington Univ. USA
 Vishore Kapoor B.Arch(Hons) chd. M.Arch, Univ. of Illinois, USA
 Vineeta Kapoor B.Arch (Hons) Chandigarh
 Anupama Kapoor B.Arch, Chandigarh

Architects, Engineers, Computer-Aided Design
 100B, Pattiputra Colony, Near Notre Dame Academy
 Opposite P&M Mall, Patna-800 013
 Tel: 0612-2267175, Fax: 0612-2275624
 Email: contact@kapoors.biz

REF:PMC/0033/2018		August 2nd, 2018		
SUMMARY OF COST FOR VENDING ZONE:- PATNA MUNICIPAL CORPORATION, PATNA				
CONSULTANTS: KAPOOR AND ASSOCIATES				
SL.NO	DESCRIPTION	AMOUNT		
	NUMBER OF HAWKERS ACCOMODATED = 564 HAWKERS			
I	TYPICAL VENDING ZONE (to accommodate 12 hawkers)			
a	Tensile Structures including foundation	458388.00 ✓		
b	Civil Works			
	i) Major Works	468823.49 503549.00 ✓		
	ii) Water Related Works	57457.88 60267.00 ✓		
c	PHE Works	42712.76 44533.00 ✓		
d	Street Furniture, Lighting, Signage, etc. L.S	300000.00 ✓		
	SUBTOTAL-I	1327382.13 1366737.00		
	38 nos. Normal Vending Zone with 12 hawkers each (456 HAWKERS)	50440520.98 5,19,36,006.00 ✓ (1)		
II	TYPICAL MEAT ZONE (to accommodate 18 hawkers)			
a	Tensile Structures including foundation	1568750.00		
b	Civil Works			
	i) Major Works	1325309.62 1386194.00 ✓		
	ii) Water Related Works	57457.88 60,267.00 ✓		
c	PHE Works	42712.76 44533.00 ✓		
d	Street Furniture, Lighting, Signage, etc.	300000.00		
	SUBTOTAL-II	3294230.26 3359741.00		
	2 nos. Meat Vending Zone with 18 hawkers each (36 HAWKERS)	6588460.52 67,19,788.00 ✓ (2)		
III	TYPICAL VEGETABLE ZONE (to accommodate 36 hawkers)			
a	Tensile Structures including foundation	1568750.00		
b	Civil Works			
	i) Major Works	990003.55 1036619.00 ✓		
	ii) Water Related Works	57457.88 60,267.00 ✓		

331

OK A P O O R A N D A S S O C I A T E S

Ravi Kapoor B.Arch, Chd, M.Arch, IIT-KGP, M.Arch & U.D Washington Univ. USA
 Kishore Kapoor B.Arch(Hons) chd. M.Arch, Univ. of Illinois, USA
 Vineeta Kapoor B.Arch (Hons) Chandigarh
 Anupama Kapoor B.Arch, Chandigarh

Architects, Engineers, Computer-Aided Design
 100B, Patliputra Colony, Near Notre Dame Academy
 Opposite P&M Mall, Patna-800 013
 Tel: 0612-2267175, Fax: 0612-2275624
 Email: contact@kapoors.biz

REF:PMC/0032/2018		August 2nd, 2018	
COSTS FOR TYPICAL VENDING ZONES:-			
PATNA MUNICIPAL CORPORATION, PATNA			
CONSULTANTS: KAPOOR AND ASSOCIATES			
SL.NO	DESCRIPTION	AMOUNT	
I	TYPICAL VENDING ZONE		
	(to accommodate 12 hawkers)		
a	Tensile Structures including foundation	458388.00	
b	Civil Works		
	i) Major Works	468823.49	
	ii) Water Related Works	57457.88	
c	PHE Works	42712.76	
d	Street Furniture, Lighting, Signage, etc.	300000.00	
	SUBTOTAL-I	1327382.13	
II	TYPICAL MEAT ZONE		
	(to accommodate 18 hawkers)		
a	Tensile Structures including foundation	1568750.00	
b	Civil Works		
	i) Major Works	1325309.62	
	ii) Water Related Works	57457.88	
c	PHE Works	42712.76	
d	Street Furniture, Lighting, Signage, etc.	300000.00	
	SUBTOTAL-II	3294230.26	
III	TYPICAL VEGETABLE ZONE		
	(to accommodate 36 hawkers)		
a	Tensile Structures including foundation	1568750.00	
b	Civil Works		
	i) Major Works	990003.55	
	ii) Water Related Works	57457.88	
c	PHE Works	42712.76	
d	Street Furniture, Lighting, Signage, etc.	300000.00	
	SUBTOTAL-III	2958924.19	

336

K A P O O R A N D A S S O C I A T E S

Ravi Kapoor B.Arch, Chd, M.Arch, IIT-KGP, M.Arch & U.D Washington Univ. USA
 Kishore Kapoor B.Arch(Hons) chd. M.Arch, Univ. of Illinois, USA
 Vineeta Kapoor B.Arch (Hons) Chandigarh
 Anupama Kapoor B.Arch, Chandigarh

Architects, Engineers, Computer-Aided Design
 100B, Patliputra Colony, Near Notre Dame Academy
 Opposite P&M Mall, Patna-800 013
 Tel: 0612-2267175, Fax: 0612-2275624
 Email: contact@kapoors.biz

REF:PMC/0030/2018		August 2nd, 2018
-------------------	--	------------------

ABSTRACT OF COST FOR CIVIL WORKS

NORMAL VENDING ZONE, BORING CANAL ROAD, PATNA

PATNA MUNICIPAL CORPORATION

CONSULTANTS: KAPOOR AND ASSOCIATES

27.09.2018

BASED ON S.O.R. B.C.D. GOVT. OF BIHAR EFFECTIVE FROM 17/10/2016/DSR-2016/MR

SL.NO		DESCRIPTION	UNIT	QTY.	RATE	AMOUNT
1	2.6	Earth work in excavation over areas (exceeding 30 cm in depth. 1.5 m in width as well es 10 sqm on plan) including disposal of excavated earth , lead upto 50 m and lift upto 1.5 m; disposed earth to be levelled and neatly dressed.			279.10	2877.00
	2.6.1	All kinds of soil	Cum	10.30	225.40	2321.62
2	2.28	Supplying and Filling in plinth with local sand and under floors including watering, ramming consolidating and dressing complete.	cum	2.45	238.60 204.40	585.00 500.78
3	11.72 A-1.5 B-c/d	Providing designation 100A one brick flat soling joints filled with local sand including cost of watering, taxes, royalty all complete as per building specification and direction of E/I. P.CC (1:3:6)	sqm sqm	1.447 1.20	3461.40 252.80	5009.00 4898.34
4	4.1	Providing and laying in position cement concrete of specified grade excluding the cost of centering and shuttering-All work up to plinth level:				
	4.1.3	1:2:4(1 Cement:3 coarse sand: 6 graded stone aggregate 20mm nominal size)	cum	26.11	4151.40 3850.50	1,08,393.00 100536.56
5	4.4	Providing and faying cement concrete in kerbs, steps and the like at or near ground level excluding the cost of centring, shuttering and finishing.				
	4.4.1	1:2:4 (1 Cement :2 coarse sand :4 grade stone aggregate 20mm nominal size)	Cum	2.66	4151.40 3850.50	1,04,43.00 10242.33
6	6.114A+ 6.3A 6.1.12C 4895.70 702.20 5597.90	Brick work with bricks of class designation 100A in foundation and plinth in Cement mortar 1:6(1 cement:6 coarse sand) with ply 9sk bnck Extra for Brick work in superstructure above plinth level upto floor V Level				
			Cum	4.96	5597.90 5003.90	27,766.00 24819.34
7	10.32	Steel work welded in built up sections/framed work including cutting hoisting, rixing in position and applying a priming coat of approved steel primer using structural steel, etc. as required.				
	10.32.2	In gratings, frames, guard bar, ladders, railings, brackts. gates & similar works.	Kg	1024.00	88.80 76.70	90931.00 78540.80
8	13.13	20mm cement plaster of mix:				
	13.13.4	1:6(1 cement: 6 coarse sand)	sqm	47.30	173.00 140.40	8183.00 6640.92
9	13.80A.2	Providing and applying white cement based putty of average thickness 2 mm, of approved brand and manufacturer, over the plastered wall surface to prepare the surface even and smooth complete.	sqm	47.30	46.50 118.40	2199.00 5600.32
10	13.46	Finishing walls with Acrylic Smooth exterior paint of required shade :				

257986.00

235

	13.46.1	New work (Two or more coat applied @ 1.67 ltr/.10 sqm over and including priming coat of exterior primer applied @ 2.20 kg/ 10 sqm)	sqm	47.30	89.40 71.10	4229.00 3363.03
11	13.94	Painting with synthetic enamel paint of approved brand and manufacture of required colour to give an even shade:				
	13.94.1	Two or more coats on new work over an under coat of suitable shade with ordinary paint of approved brand and manufacture.	sqm	38.66	96.10 75.20	3715.00 2907.23
12	11.26	Kota stone slab flooring over 20mm (average) thick base laid over and jointed with grey cement slurry mixed with pigment to match the shade of the slab including rubbing and polishing complete. Base with 1:1:1 (1 lime : 1 surkhi: 1 coarse sand) / 1:4 (1 cement: 4 coarse sand)				
	11.26.1	20 to 25mm thick	sqm	117.10	998.30	146900.93
13	11.27	Kota stone slab 20mm thick in risers of steps skirting. Dado & pillars laid on 12mm (average thick cement mortar 1:3(1 cement: 3 coarse sand) and jointed with grey cement slurry mixed with pigment to match the shade of the slab including rubbing and polishing complete.	sqm	6.27	1133.90 923.00	7110.00 6100.71
14	5.3	Reinforced cement concrete work in beams,suspended floors, roofs having slope upto 15, landings,balconiec, shelves, chajjas, lintels, bands, plain window sills, staircases and spiral stair cases upto floor five level excludingthe cost of centring, shuttering, finishing and reinforcement with 1:2:4(1 cement:2 coarse sand:4 graded stone aggregate 20 mm nominal size).	Cum	1.26	5258.20 4671.80	6025.00 5886.47
15	5.33B	Add or deduct for providing richer or leaner mixes respectively at all floor levels.				
	5.33B.4	Providing M-15grade R.C.C instead of M-20 grade R.C.C.	Cum	1.26	461.40 453.10	581.00 570.91
16	5.9	Centering and shuttering including strutting, propping etc. and removal of form for:				
	5.9.1	Foundations, footings, bases of columns, etc. for mass concrete.	Sqm	8.71	186.30 169.00	1623.00 1471.99
	5.9.6	Columns, Pillars, Piers, Abutments, Posts and Struts.	sqm	17.33	357.00 425.80	6197.21 737
	5.9.5	Lintels, beams, plinth beams, girders, bressumers and cantilevers.	sqm	1.30	261.70 335.30	436.00 340.21
17	5.22	Reinforcement for R.C.C work including straightening, cutting, bending, placing in position and binding all complete.				
	5.22.7A	Thermo-Mechanically Treated bars TMTC-500-8mm dia	Kg	54.00	77.40 56.00	4180.00 3024.00
	5.22.7B	Thermo-Mechanically Treated bars TMTC-500-10mm dia	Kg	80.00	76.70 54.70	6136.00 4376.00
18	4.11	Providing and laying damp-proof course 50mm thick with cement concrete 1:2:4(1 cement: 2 coarse sand: 4 graded stone aggregate 20mm nominal size).	Sqm	2.16	245.50 251.20	530.00 542.59
19	4.12	Extra for providing and mixing water proofing material in cement concrete work in the proportion recommended by the manufacturers.	per 50 kg cement	2.00	52.85 46.58	105.00 93.16
20		Add Carriage of Materials with Loading & Unloading				
		Bricks lead of (1K+7P) — <i>ply 95k bricks</i>	% No.	2451	693.47	1700=
		Stone chips (200KM P) from Koderma	cum	28.12	24.04	53747.19
		Coarse sand 50KM (1K+49P) from Koilwar	cum	19.41	18.27	12060.76
		Local sand(1K+2P)	cum	2.45	181.48	444.63

262.05

642=0
494149=2
49584

	Cement (5kmP)	Tone	10.29 12.422	282.30 290.27	2904.87
	Steel (5kmP)	Tone	0.134	282.30	37.83 39.0
20	Differences cost of materials			290.27	
	Bricks 100A (Patna Urban)	% No.	2637.00	1660.43	4378.55
	Cement (Patna Urban) (P.S.C)	Tone	10.29 12.422	774.92 326.45	7973.93 4055.2
	TOTAL				468823.49
					501849.2
					503549.2

7

K A P O O R A N D A S S O C I A T E S

Ravi Kapoor B.Arch, Chd, M.Arch, IIT-KGP, M.Arch & U.D Washington Univ. USA
 Kishore Kapoor B.Arch(Hons) chd. M.Arch, Univ. of Illinois, USA
 Vineeta Kapoor B.Arch (Hons) Chandigarh
 Anupama Kapoor B.Arch, Chandigarh

Architects, Engineers, Computer-Aided Design
 100B, Patliputra Colony, Near Notre Dame Academy
 Opposite P&M Mall, Patna-800 013
 Tel: 0612-2267175, Fax: 0612-2275624
 Email: contact@kapoors.biz

REF:PMC/0029/2018			August 2nd, 2018
-------------------	--	--	------------------

ABSTRACT OF COST FOR CIVIL WORKS

MEAT VENDING ZONE, BORING CANAL ROAD, PATNA

PATNA MUNICIPAL CORPORATION

CONSULTANTS: KAPOOR AND ASSOCIATES

27-09-2018

BASED ON S.O.R. B.C.D.GOV.T. OF BIHAR EFFECTIVE FROM 17/10/2016/DSR-2016/MR

SL.NO	DESCRIPTION	UNIT	QTY.	RATE	AMOUNT
1	2.6 Earth work in excavation over areas (exceeding 30 cm in depth. 1.5 m in width as well es 10 sqm on plan) including disposal of excavated earth , lead upto 50 m and lift upto 1.5 m; disposed earth to be levelled and neatly dressed.			279.10	4547.00
	2.6.1 All kinds of soil	Cum	16.29	225.40	3671.77
2	2.28 Supplying and Filling in plinth with local sand and under floors including watering, ramming consolidating and dressing complete.	cum	47.91	238.60 204.40	11431.00 9792.80
3	11.72 4-1-5 B.C.D. Providing designation 100A one brick flat soling joints filled with local sand including cost of watering, taxes, royalty all complete as per building specification and direction of E/I. CP-Ce 1.3.6	sqm	6.525 87.00	3461.40 252.80	22586.00 22080.60
4	4.1 Providing and laying in position cement concrete of specified grade excluding the cost of centering and shuttering-All work up to plinth level:				
	4.1.3 1:2:4(1 Cement:3 coarse sand: 6 graded stone aggregate 20mm nominal size)	cum	60.72	4151.40 3850.50	252073 232802.36
5	5.3 Reinforced cement concrete work in beams,suspended floors, roofs having slope upto 15, landings,balconic, shelves, chajjas, lintels, bands, plain window sills, staircases and spiral stair cases upto floor five level excluding the cost of centring, shuttering, finishing and reinforcement with 1:2:4(1 cement:2 coarse sand:4 graded stone aggregate 20 mm nominal size).	Cum	8.95	5258.20 4671.80	470617 41812.61
6	5.33B Add or deduct for providing richer or leaner mixes respectively at all floor levels.				
	5.33B.4 Providing M-15grade R.C.C instead of M-20 grade R.C.C.	Cum	8.95	461.40 452.10	41502 4055.25
7	5.9 Centering and shuttering including strutting, propping etc. and removal of form for:				
	5.9.1 Foundations, footings, bases of columns, etc. for mass concrete.	Sqm	15.12	186.30 169.00	2817.00 2555.28
	5.9.6 Columns, Pillars, Piers, Abutments, Posts and Struts.	sqm	42.38	357.00	15155.09
	5.9.5 Lintels, beams, plinth beams, girders, bressumers and cantilevers.	sqm	47.76	425.50 261.70	2033 12498.79
8	5.22 Reinforcement for R.C.C work including straightening, cutting, bending, placing in position and binding all complete.				
	5.22.1B Mild steel 6.0 mm dia	Kg	50.00	75.90 54.30	3798 2715.00
	5.22.7A Thermo-Mechanically Treated bars TMTC-500-8mm dia	Kg	300.00	77.40 56.00	23220 16800.00

410041

(135)

	5.22.7B	Thermo-Mechanically Treated bars TMTC-500-10mm dia	Kg	600.00	76.70 54.70	46620.2 32820.00
9	6.1.14A+ 6.3A.2c 6.1.14B	Brick work with bricks of class designation 100A in foundation and plinth in: Cement mortar 1:6(1 cement:6 coarse sand) with fly ash brick.				
		Extra for Brick work in superstructure above plinth level upto floor V Level	Cum	29.80	5597.90 5003.90	166,281.2 149116.22
10	6.18.4A +6.19Ac 6.1.14B 6.3c	Half brick masonry with bricks of class designation 100A in foundations and plinth in :Cement mortar 1:4 (1 cement:4 coarse send)				
		Extra for half Brick masonry in superstructure above pinth level upto floor V level.	M³ sqm	20.70 165.61	5831.90 608.40	1,20720.2 100757.12
11	11.26	Kota stone slab flooring over 20mm (average) thick base laid over and jointed with grey cement slurry mixed with pigment to match the shade of the slab including rubbing and polishing complete. Base with 1:1:1 (1 lime : 1 surkhi: 1 coarse sand) / 1:4 (1 cement: 4 coarse sand)				
	11.26.1	20 to 25mm thick	sqm	192.56	998.30	192232.65
12	11.27	Kota stone slab 20mm thick in risers of steps skirting. Dado & pillars laid on 12mm (average thick cement mortar 1:3(1 cement: 3 coarse sand) and jointed with grey cement slurry mixed with pigment to match the shade of the slab including rubbing and polishing complete.	sqm	21.93	1133.90 973.00	24,866.2 21337.89
13	11.36	Providing and fixing 1st quality ceramic glazed wall tiles conforming to IS:15622(thickness to be specified by the manufacture) of approved make in all colours, shades except burgundy, bottle green, black of any size as approved by Engineer-in-Charge in skirting, risers of steps and dados over 12mm thick bed of cement Mortar 1:3(1 cement: 3 coarse sand) and jointing with grey cement slurry @ 3.3 kg per sqm including pointing in white cement mixed with pigment of matching shade complete.	sqm	193.54	739.90 766.30	1,43,181.2 148309.70
14	13.13	20mm cement plaster of mix:				
	13.13.4	1:6(1 cement: 6 coarse sand)	sqm	146.84	173.60 140.40	25,463.2 20616.34
15	13.80A.2	Providing and applying white cement based putty of average thickness 2 mm, of approved brand and manufacturer, over the plastered wall surface to prepare the surface even and smooth complete.	sqm	146.84	46.50 118.40	6828.2 17385.86
16	13.46	Finishing walls with Acrylic Smooth exterior paint of required shade :				
	13.46.1	New work (Two or more coat applied @ 1.67 ltr/ 10 sqm over and including priming coat of exterior primer applied @ 2.20 kg/ 10 sqm)	sqm	146.84	89.40 21.10	13,127.2 10440.32
17	4.11	Providing and laying damp-proof course 50mm thick with cement concrete 1:2:4(1 cement: 2 coarse sand: 4 graded stone aggregate 20mm nominal size).	Sqm	19.44	245.50 251.20	4773.0 4883.33
18	4.12	Extra for providing and mixing water profing material in cement concrete work in the proportion recommended by the manufacturers.	per 50 kg cement	3.00	52.35 46.58	157.2 139.74
19		Add Carriage of Materials with Loading & Unloading				
		Bricks lead of (1K+7P) fly ash bricks.	% No.	20586.00 24947	531.02 693.47	10889.10 17300.2
		Stone chips (200KM P) from Koderma	cum	65483.43	1576.74	141812.99
		Coarse sand 50KM (1K+49P)) from Koilwar	cum	50254.55	896.00	36010.64
		Local sand(1K+2P)	cum	47.91	262.48	8694.71
		Cement (5kmP)	Tone	33528.95	296.28	8172.59
		Steel (5kmP)	Tone	0.958	282.30	268.19

290.27

13,75.2

K A P O O R A N D A S S O C I A T E S

Ravi Kapoor B.Arch, Chd, M.Arch, IIT-KGP, M.Arch & U.D Washington Univ. USA
 Kishore Kapoor B.Arch(Hons) chd. M.Arch, Univ. of Illinois, USA
 Vineeta Kapoor B.Arch (Hons) Chandigarh
 Anupama Kapoor B.Arch, Chandigarh

Architects, Engineers, Computer-Aided Design
 100B, Patliputra Colony, Near Notre Dame Academy
 Opposite P&M Mall, Patna-800 013
 Tel: 0612-2267175, Fax: 0612-2275624
 Email: contact@kapoors.biz

REF:PMC/0031/2018	August 2nd, 2018
-------------------	------------------

ABSTRACT OF COST FOR CIVIL WORKS

VEGETABLE VENDING ZONE, BORING CANAL ROAD, PATNA PATNA MUNICIPAL CORPORATION

CONSULTANTS: KAPOOR AND ASSOCIATES

27-09-2018

BASED ON S.O.R. B.C.D.GOV'T. OF BIHAR EFFECTIVE FROM 17/10/2016/DSR-2016/MR

SL.NO	DESCRIPTION	UNIT	QTY.	RATE	AMOUNT
1	2.6 Earth work in excavation over areas (exceeding 30 cm in depth. 1.5 m in width as well es 10 sqm on plan) including disposal of excavated earth , lead upto 50 m and lift upto 1.5 m; disposed earth to be levelled and neatly dressed.			<i>279.10</i>	<i>4547.00</i>
	2.6.1 All kinds of soil	Cum	16.29	225.40	<i>3671.77</i>
2	2.28 Supplying and Filling in plinth with local sand and under floors including watering, ramming consolidating and dressing complete.	cum	21.40	238.60 <i>204.40</i>	<i>5106.00</i> 4374.16
3	<i>11.72</i> <i>4.1.5</i> <i>B.C.D</i> Providing designation 100A one brick flat soling joints filled with local sand including cost of watering, taxes, royalty all complete as per building specification and direction of E/I. <i>P. CC (1.3.5)</i>	<i>173</i> sqm	<i>6.525</i> 82.00	<i>3461.40</i> 253.80	<i>22586.00</i> 22080.60
4	4.1 Providing and laying in position cement concrete of specified grade excluding the cost of centering and shuttering-All work up to plinth level:				
	4.1.3 1:2:4(1 Cement:3 coarse sand: 6 graded stone aggregate 20mm nominal size)	cum	49.64	4151.40 <i>3850.50</i>	206075.00 <i>191138.82</i>
5	5.3 Reinforced cement concrete work in beams,suspended floors, roofs having slope upto 15, landings,balconic, shelves, chajjas, lintels, bands, plain window sills, staircases and spiral stair cases upto floor five level excludingthe cost of centring, shuttering, finishing and reinforcement with 1:2:4(1 cement:2 coarse sand:4 graded stone aggregate 20 mm nominal size).	Cum	5.63	5258.20 <i>4671.80</i>	29504.00 <i>26302.23</i>
6	5.33B Add or deduct for providing richer or leaner mixes respectively at all floor levels.				
	5.33B.4 Providing M-15grade R.C.C instead of M-20 grade R.C.C.	Cum	5.63	461.40 <i>453.10</i>	2598.00 <i>2550.95</i>
7	5.9 Centering and shuttering including strutting, propping etc. and removal of form for:				
	5.9.1 Foundations, footings, bases of columns, etc. for mass concrete.	Sqm	12.20	186.30 <i>169.00</i>	2273.00 <i>2061.80</i>
	5.9.6 Columns, Pillars, Piers, Abutments, Posts and Struts.	sqm	26.77	357.60 <i>425.80</i>	2572.95 <i>1135</i>
	5.9.5 Lintels, beams, plinth beams, girders, bressumers and cantilevers.	sqm	22.30	261.70 <i>335.30</i>	5835.91 <i>7477.00</i>
8	5.22 Reinforcement for R.C.C work including straightening, cutting, bending, placing in position and binding all complete.				
	5.22.1B Mild steel 6.0 mm dia	Kg	50.00	54.30 <i>75.90</i>	2715.00 <i>3795.00</i>
	5.22.7A Thermo-Mechanically Treated bars TMTC-500-8mm dia	Kg	296.00	56.00 <i>77.40</i>	16576.00 <i>22910.00</i>

120

K A P O O R A N D A S S O C I A T E S

Ravi Kapoor B.Arch, Chd, M.Arch, IIT-KGP, M.Arch & U.D Washington Univ. USA
 Kishore Kapoor B.Arch(Hons) chd. M.Arch, Univ. of Illinois, USA
 Vineeta Kapoor B.Arch (Hons) Chandigarh
 Anupama Kapoor B.Arch, Chandigarh

Architects, Engineers, Computer-Aided Design
 100B, Palliputra Colony, Near Notre Dame Academy
 Opposite P&M Mall, Patna-800 013
 Tel: 0612-2267175, Fax: 0612-2275624
 Email: contact@kapoors.biz

REF:PMC/0028/2018		August 2nd, 2018
-------------------	--	------------------

ABSTRACT OF COST FOR CIVIL WORKS

WATER ZONE, BORING CANAL ROAD, PATNA

PATNA MUNICIPAL CORPORATION

CONSULTANTS: KAPOOR AND ASSOCIATES

27.09.2018

BASED ON S.O.R. B.C.D.GOV. OF BIHAR EFFECTIVE FROM 17/10/2016/DSR-2016/MR-

SL.NO		DESCRIPTION	UNIT	QTY.	RATE	AMOUNT
1	2.6	Earth work in excavation over areas (exceeding 30 cm in depth. 1.5 m in width as well es 10 sqm on plan) including disposal of excavated earth , lead upto 50 m and lift upto 1.5 m; disposed earth to be levelled and neatly dressed.			279.10	466.00
	2.6.1	All kinds of soil	Cum	1.67	225.40	376.42
2	2.28	Supplying and Filling in plinth with local sand and under floors including watering, ramming consolidating and dressing complete.	cum	0.37	238.60	88.00
					204.40	75.63
3	11.72	Providing designation 100A one brick flat soling joints filled with local sand including cost of watering, taxes, royalty all complete as per building specification and direction of E.I. p.c.c (1:3:6)	M ² sqm	0.27	3461.40	935.00
					253.80	226.37
4	5.1	Providing and laying in position specified grade of reinforced cement concrete excluding the cost of centring,shuttering,finishing and reinforcement-All work upto plinth level				
	5.1.2	1:1:5:3(1 cement: 1.5 coarse sand:3 graded stone aggregate 20 mm nominal size)	Cum	0.74	4902.30	3628.00
					4530.30	3352.42
5	5.3	Reinforced cement concrete work in beams,suspended floors, roofs having slope upto 15, landings,balconies, shelves, chajjas, lintels, bands, plain window sills, staircases and spiral stair cases upto floor five level excluding the cost of centring, shuttering, finishing and reinforcement with 1:2:4(1 cement:2 coarse sand:4 graded stone aggregate 20 mm nominal size).	Cum	0.70	5258.20	3681.00
					4671.80	3270.26
6	5.33B	Add or deduct for providing richer or leaner mixes respectively at all floor levels.				
	5.33B.4	Providing M-15grade R.C.C instead of M-20 grade R.C.C.	Cum	0.70	461.40	323.00
					453.70	317.17
7	5.9	Centering and shuttering including strutting, propping etc. and removal of form for:				
	5.9.1	Foundations, footings, bases of columns, etc. for mass concrete.	Sqm	2.41	186.30	449.60
					169.00	407.29
	5.9.6	Columns, Pillars, Piers, Abutments, Posts and Struts.	sqm	5.76	357.60	2059.78
	5.9.5	Lintels, beams, plinth beams, girders, bressumers and cantilevers.	sqm	0.76	415.80	255.80
					261.70	198.89
8	5.22	Reinforcement for R.C.C work including straightening, cutting, bending, placing in position and binding all complete.			335.30	
	5.22.7A	Thermo-Mechanically Treated bars TMTC-500-8mm dia	Kg	43.00	77.40	3328.00
					56.00	2408.00

(27)

	5.22.7B	Thermo-Mechanically Treated bars TMTC-500-10mm dia	Kg	50.00	76.70 54.70	3835.00 2735.00
9	4.11	Providing and laying damp-proof course 50mm thick with cement concrete 1:2:4(1 cement: 2 coarse sand: 4 graded stone aggregate 20mm nominal size).	Sqm	1.26	245.50 251.20	309.00 316.51
10	4.12	Extra for providing and mixing water proofing material in cement concrete work in the proportion recommended by the manufacturers.	per 50 kg cement	1.00	52.35 46.58	52.00 46.58
11	4.1	Providing and laying in position cement concrete of specified grade excluding the cost of centering and shuttering-All work up to plinth level:				
	4.1.3	1:2:4(1 Cement:3 coarse sand: 6 graded stone aggregate 20mm nominal size)	cum	0.34	4151.40 3850.30	1411.00 1309.17
12	6.1.14A+ 6.3A 6-1:16	Brick work with bricks of class designation 100A in foundation and plinth in Cement mortar 1:6(1 cement:6 coarse sand) with fly ash bricks				
		Extra for Brick work in superstructure above plinth level upto floor V Level	Cum	2.91	5597.90 5003.90	16290.00 14561.35
13	13.13	20mm cement plaster of mix:				
	13.13.4	1:6(1 cement: 6 coarse sand)	sqm	18.30	173.00 140.40	3166.00 2569.32
14	11.26	Kota stone slab flooring over 20mm (average) thick base laid over and jointed with grey cement slurry mixed with pigment to match the shade of the slab including rubbing and polishing complete. Base with 1:1:1 (1 lime : 1 surkhi: 1 coarse sand) / 1:4 (1 cement: 4 coarse sand)				
	11.26.1	20 to 25mm thick	sqm	3.35	1119.60 998.30	3751.00 3344.31
15	11.36	Providing and fixing 1st quality ceramic glazed wall tiles conforming to IS:15622(thickness to be specified by the manufacture) of approved make in all colours, shades except burgundy, bottle green, black of any size as approved by Engineer-in-Charge in skirting, risers of steps and dados over 12mm thick bed of cement Mortar 1:3(1 cement: 3 coarse sand) and jointing with grey cement slurry @ 3.3 kg per sqm including pointing in white cement mixed with pigment of matching shade complete.	sqm	8.84	739.50 766.30	6540.00 6774.09
16	13.80A.2	Providing and applying white cement based putty of average thickness 2 mm, of approved brand and manufacturer, over the plastered wall surface to prepare the surface even and smooth complete.	sqm	18.30	46.50 118.40	851.00 2166.72
17	13.46	Finishing walls with Acrylic Smooth exterior paint of required shade :				
	13.46.1	New work (Two or more coat applied @ 1.67 ltr/ 10 sqm over and including priming coat of exterior primer applied @ 2.20 kg/ 10 sqm)	sqm	18.30	89.40 71.10	1636.00 1304.13
18		Add Carriage of Materials with Loading & Unloading			1438	693.47
		Bricks lead of (1K+7P) Fly ash bricks (8KM/lead)	% No.	1300.00	531.02	690.33
		Stone chips (200KM P) from Koderma	cum	1.83	150	3353.61
		Coarse sand 50KM (1K+49P)) from Koilwar	cum	2.34	2.31	1524.92
		Local sand(1K+2P)	cum	0.37	262787.48	67.15
		Cement (5kmP)	Tone	1.16	1.06	299.24
		Steel (5kmP)	Tone	0.093	282.30	26.25
19		Differences cost of materials			280.90	
		Bricks 100A (Patna Urban)	% No.	1300.00	1660.43	2158.56
		Cement (Patna Urban)	Tone	1.06	774.92	821.42
		TOTAL		1.16	326.45	57457.88
						60,267

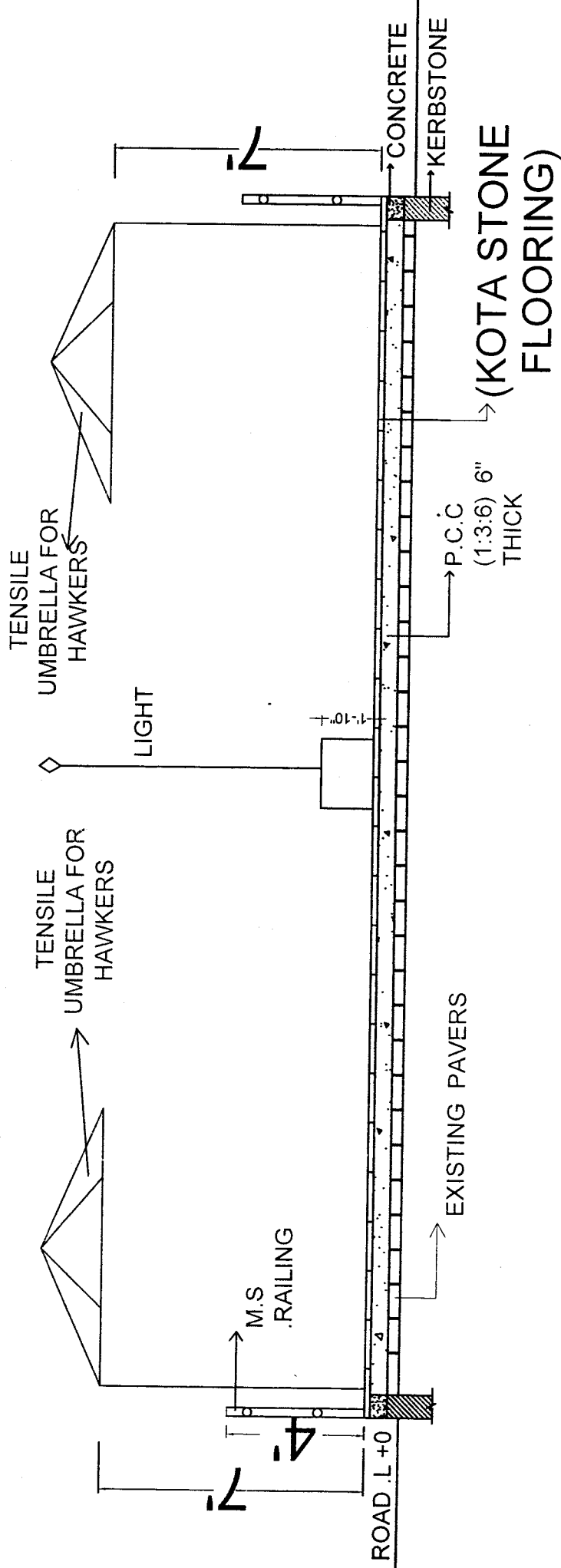

SECTION (X X)

PROJECT:- VENDING ZONE- NORMAL BORING CANAL ROAD HARTALI MORE TO RAJAPUR PUL.	SHEET TITLE:- PATNA MUNICIPAL CORPORATION PATNA		DATE :- 3-08-2018	NORTH:-
			DRAWN BY :- CHANDAN KUMAR	SHEET NO :- 2

100 - B, Padma colony, Opp. P & M Mall,
 Near Nore Duma Academy, Patna 800013
 Tel / Fax :- 2287175 / 2275824
 E contact@kapoor.inb . Web: WWW.Kapoor.inb

k&a
 Kapoor and associates
 ARCHITECTURE | INTERIOR DESIGN | URBAN DESIGN

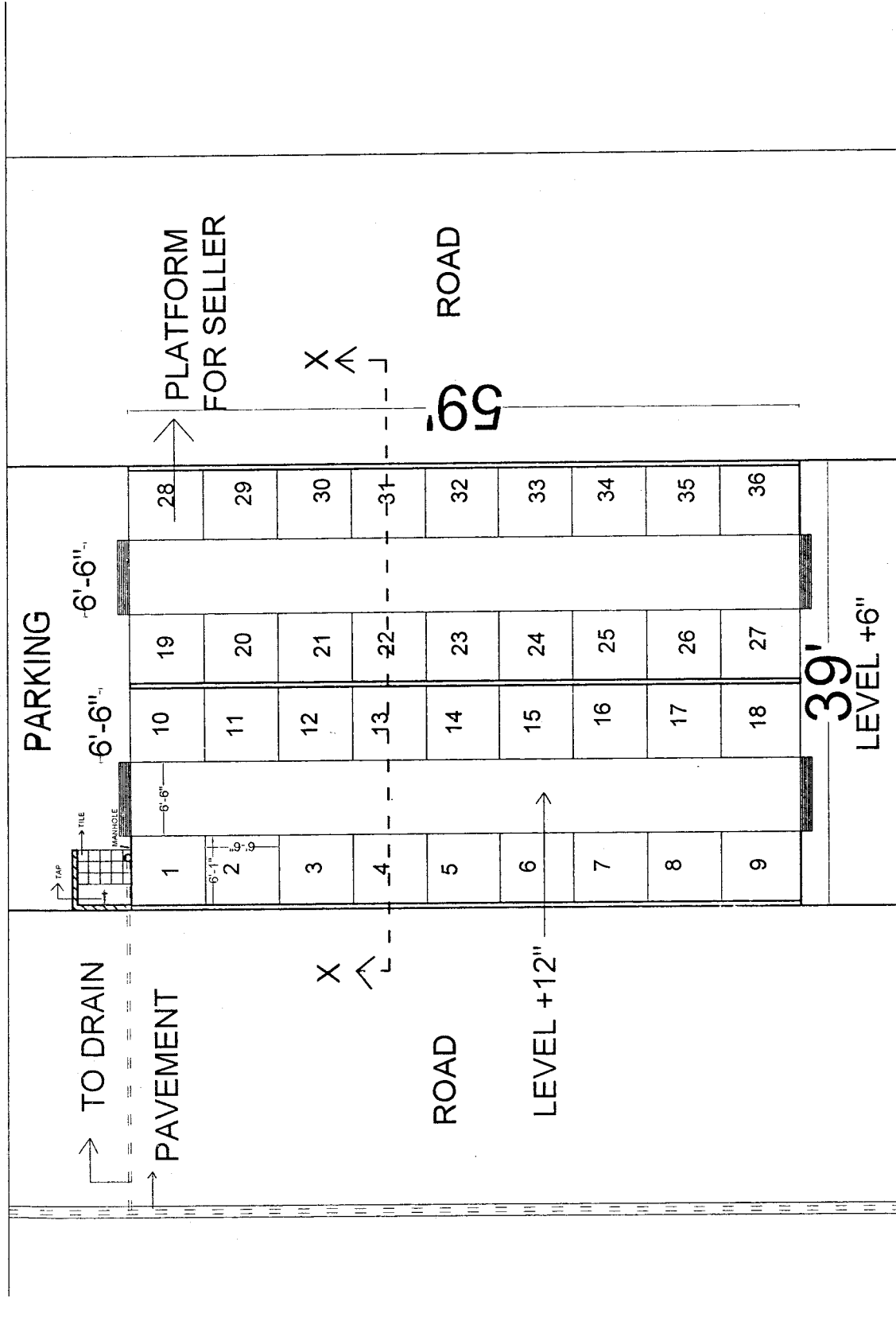

PROJECT:-

VENDING ZONE-VEGETABLE VENDING
BORING CANAL ROAD
HARTALI MORE TO RAJAPUR PUL.

SHEET TITLE:-

PATNA MUNICIPAL
CORPORATION PATNA

DATE :-

3-08-2018

NORTH:-

SHEET NO :-

3

DRAWN BY :-

CHANDAN KUMAR

100 - B, Padipurna colony, Opp. P. & M Mall,
Near Nore Dame Academy, Patna 800015
Tel / Fax : 2287176 / 2276824
E. contact@k Kapoor & associates

k&a

ARCHITECTURE | INTERIOR DESIGN | URBAN DESIGN

32

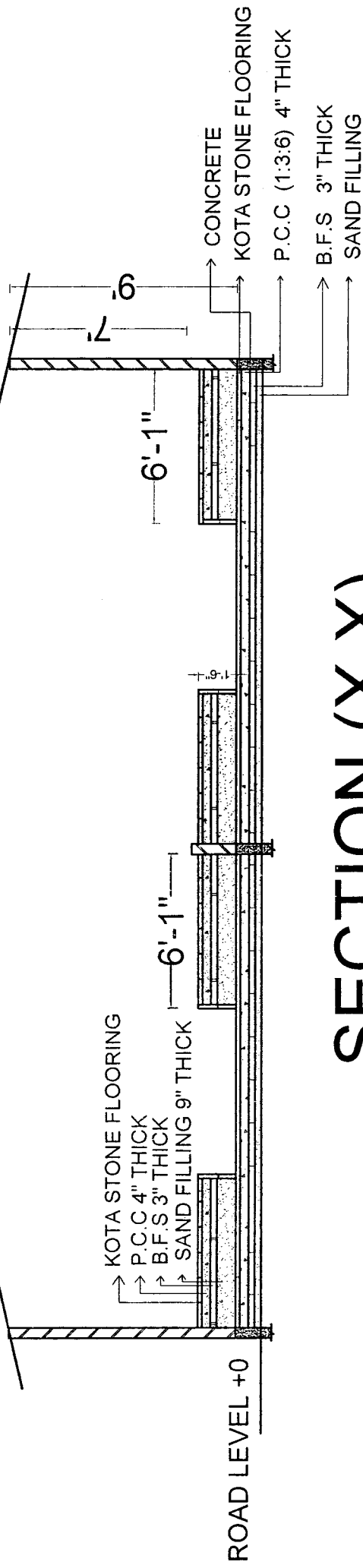

SECTION (X X)

PROJECT:-

VENDING ZONE-VEGETABLE VENDING
BORING CANAL ROAD
HARTALI MORE TO RAJAPUR PUL.

SHEET TITLE:-

PATNA MUNICIPAL
CORPORATION PATNA

DATE :-

3-08-2018

DRAWN BY :-

CHANDAN KUMAR

NORTH:-

SHEET NO :-

4

100 - B, Padma colony, Opp. P. & M Mall,
Near Nona Dama Academy, Patna 800013
Tel / Fa. n: 2287176 / 2276824
E contact@k Kapoor.biz . Web: WWW.K Kapoor.Biz

k&a

Kapoor and associates
ARCHITECTURE | INTERIOR DESIGN | URBAN DESIGN

22

100 - B, Padhyasaban colony, Opp. P. S. M. Mall,
Near Karam Dams, Anandpur, Patna - 800015
Tel / Fax no. 2287175 / 2274554
E. contact@kapoor.biz . Web: WWW.Kapoor.Biz

k&a
Kapoor and associates
ARCHITECTURE | INTERIOR DESIGN | URBAN DESIGN

TOTAL
NUMBER OF
HAWKERS=18

NORTH:-

DATE :-
3-08-2018

SHEET NO :-
5

SHEET TITLE:-

PATNA MUNICIPAL
CORPORATION PATNA

PROJECT:-

VENDING ZONE- MEAT VENDING
BORING CANAL ROAD
HARTALI MORE TO RAJAPUR PUL.

PARKING

39'

TO DRAIN
PAVEMENT

9'-10"

19'-5"

10

12

11

13

14

15

16

17

18

1

2

3

4

5

6

7

8

9

39'

ROAD

LEVEL +12"

CUTTING
DISPLAY

CUTTING
DISPLAY

CUTTING
DISPLAY

CUTTING
DISPLAY

ROAD

RAMP

LEVEL
+6"

PARKING

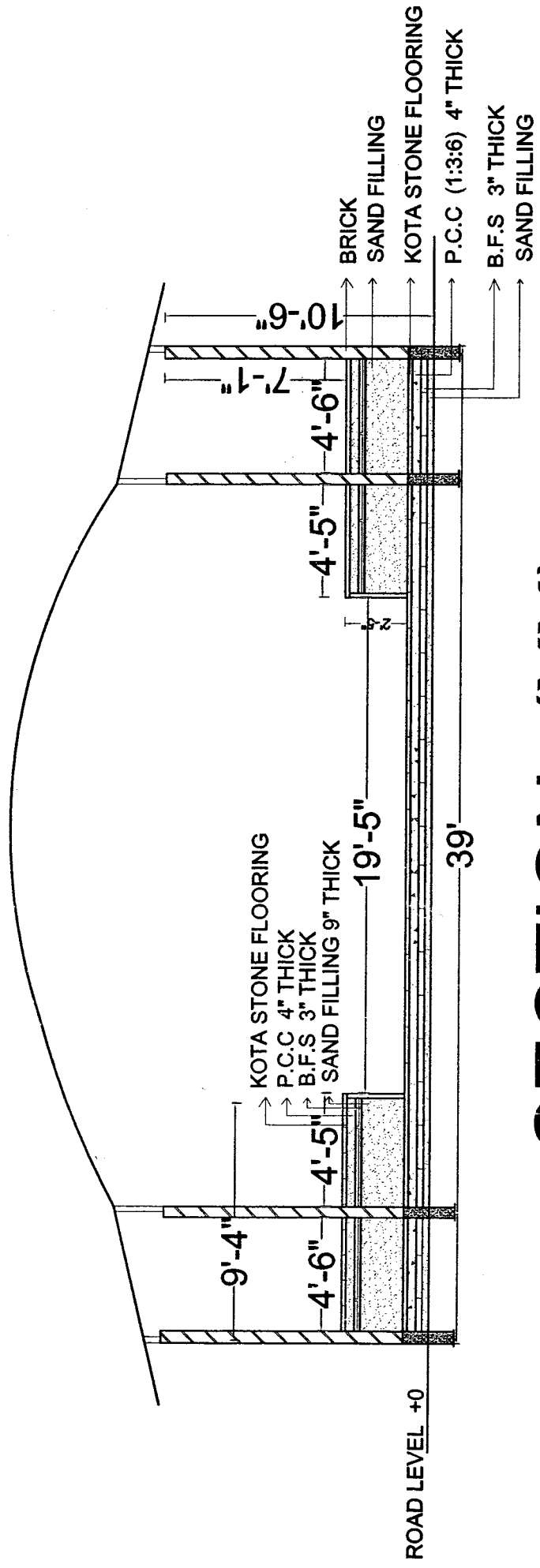

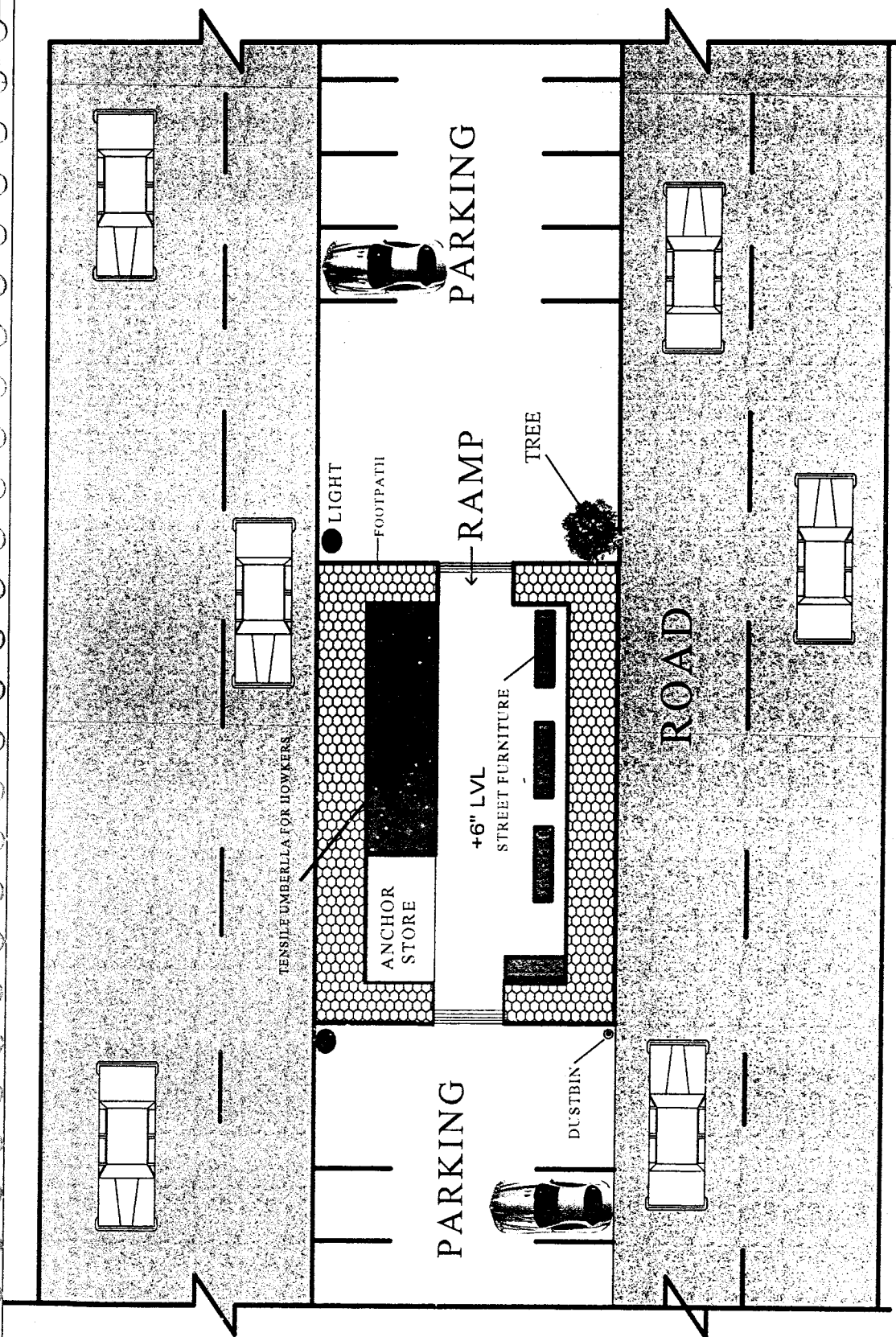

SECTION (XX)

PROJECT:- VENDING ZONE-MEAT VENDING BORING CANAL ROAD HARTALI MORE TO RAJAPUR PUL.	SHEET TITLE:- PATNA MUNICIPAL CORPORATION PATNA		DATE :- 3-08-2018	NORTH:-	100 - B, Patliputra colony, Opp. P & M Mall, Near Nore Datta Academy, Patna 800013 Tel / Fax : 2287775 / 2276824 E contact@kappaor.biz . Web: WWW.Kappaor.Biz
	DRAWN BY :- CHANDAN KUMAR		SHEET NO :- 6	ARCHITECTURE INTERIOR DESIGN URBAN DESIGN k&a Kapoor and associates	318

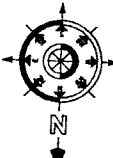

CASE - 1

PROJECT:- VENDING ZONE - BORING CANAL ROAD HARTALI MORE TO RAJAPUR PUL.	SHEET TITLE:- PLAN	CLIENT :- PATNA MUNICIPAL CORPORATION, PATNA.	DATE:- 17-07-2018 SHEET NO.:- A -01	NORTH:- 	ARCHITECTS :-  Kapoor and associates ARCHITECTURE INTERIOR DESIGN URBAN DESIGN 100 - B, Parkside colony, Opp. P & M Mall, Near Noida Durga Acacia Park, Sector 80/01/3 Tel / Fax :- 2287176 / 2278563 Email: contact@kapoorbiz.com, Web: WWW.KapoorBiz.com
--	------------------------------	--	--	---	---

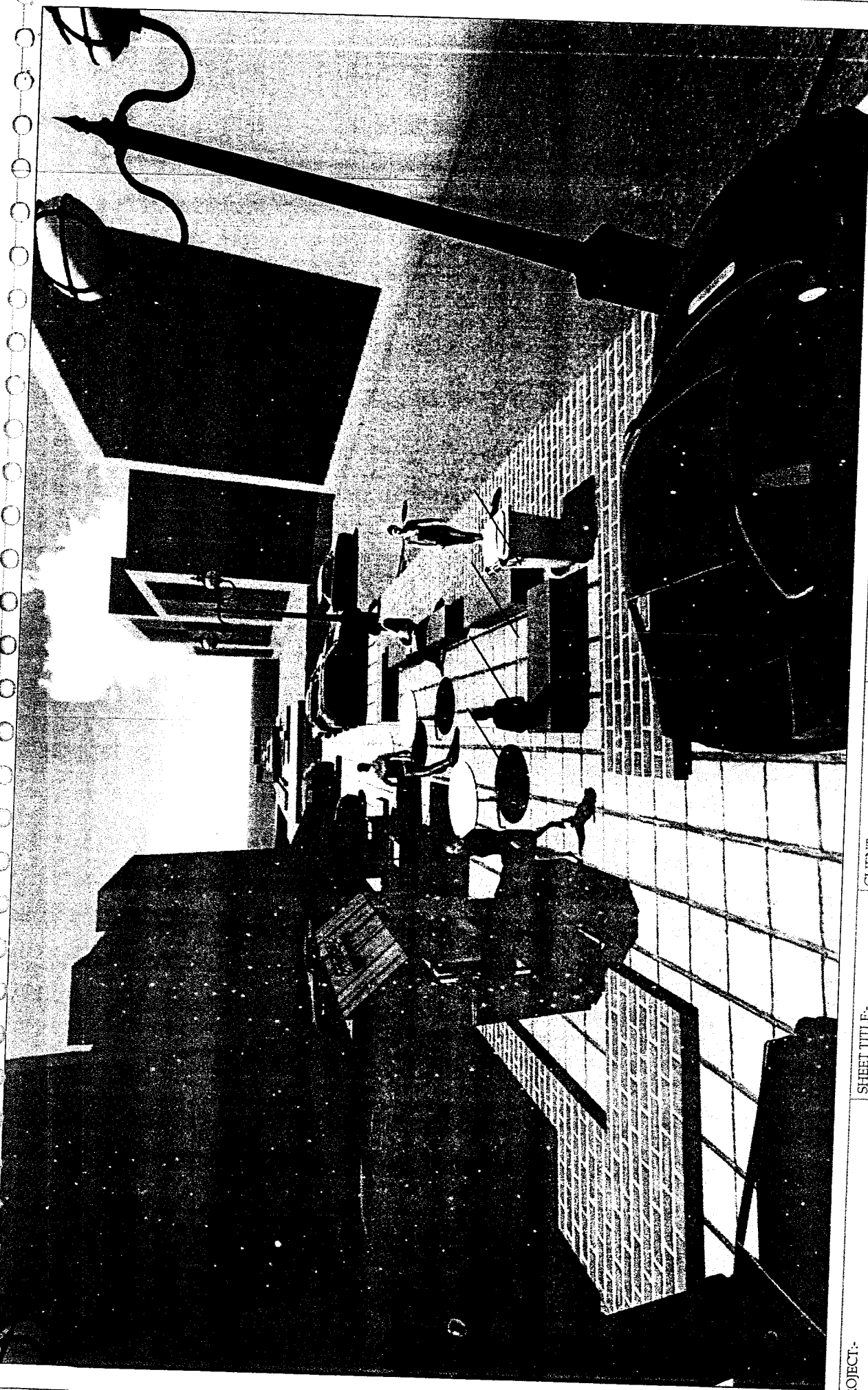

3/3

PROJECT:-

**VENDING ZONE -
BORING CANAL ROAD
HARTALI MORE TO
RAJAPUR PUL.**

SHEET TITLE:-

VIEW

CLIENT :-

**PATNA
MUNICIPAL
CORPORATION ,
PATNA.**

DATE:-

17-07-2018

SHEET NO:-

A -02

NORTH:-

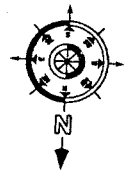

ARCHITECTS:-

100 - B, Palliputra colony, Opp. P & M Mall,
Near Notre Dame Academy, Patna 800013
Tel / Fa x: 2267775 / 2275924
Email: contact@k Kapoor's.biz, Web: WWW.KKapoor's.Biz

k&a

Kapoor and associates

ARCHITECTURE | INTERIOR DESIGN | URBAN DESIGN

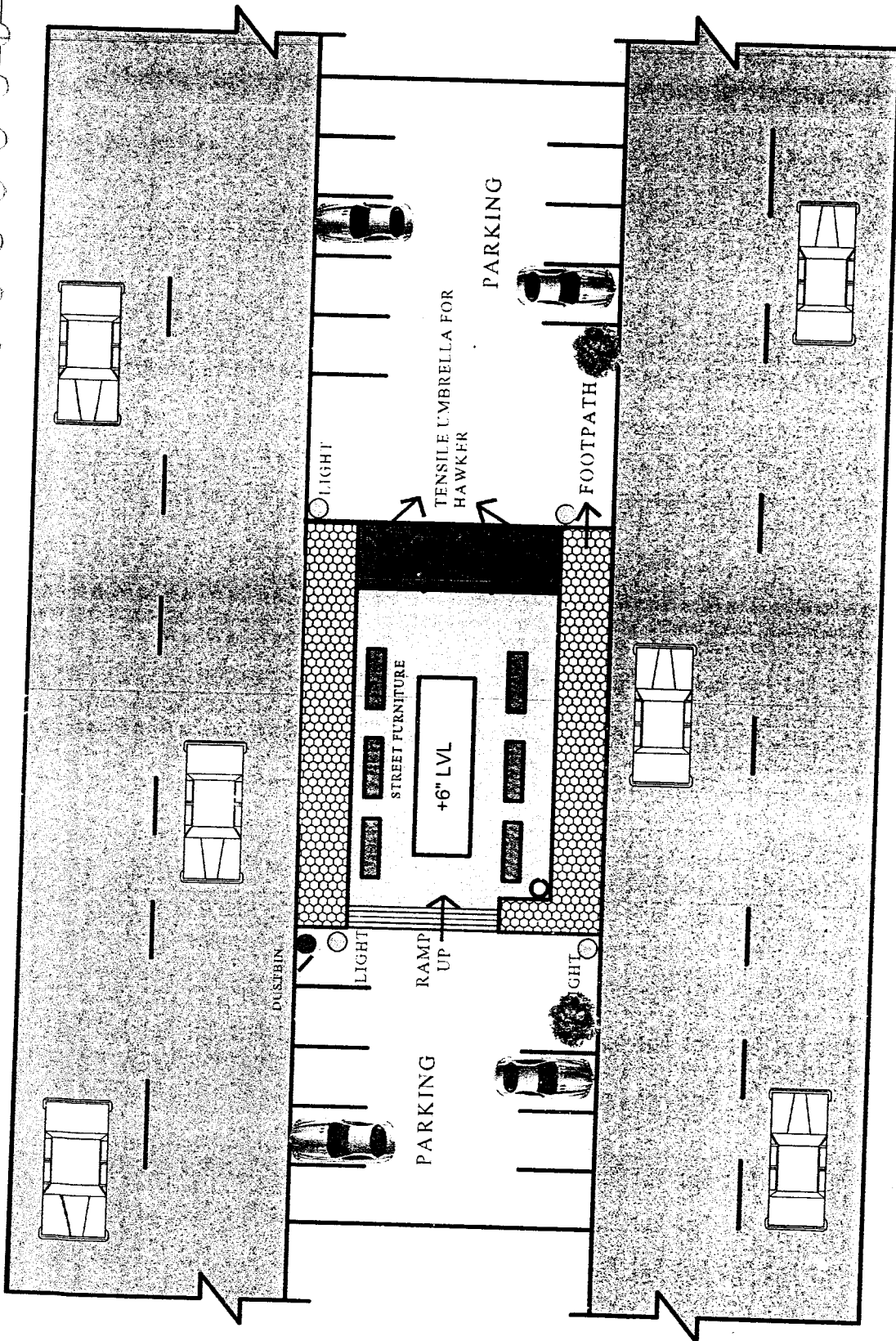

CASE - 2

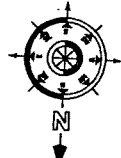
PROJECT:- VENDING ZONE - BORING CANAL ROAD HARTALI MORE TO RAJAPUR PUL.	SHEET TITLE:- PLAN	CLIENT :- PATNA MUNICIPAL CORPORATION, PATNA.	DATE > 17-07-2018 SHEET NO. > A -03	NORTH- 	ARCHITECTS :- 100 - B, Palliputra colony - Opp. P & M Mall, Near Notre Dame Academy, Patna 800013 Tel / Fa. x: 2287171 / 2275524 Email: contact@k Kapoor and associates k&a Kapoor and associates ARCHITECTURE INTERIOR DESIGN URBAN DESIGN	216
--	------------------------------	--	--	--	--	-----

3/15

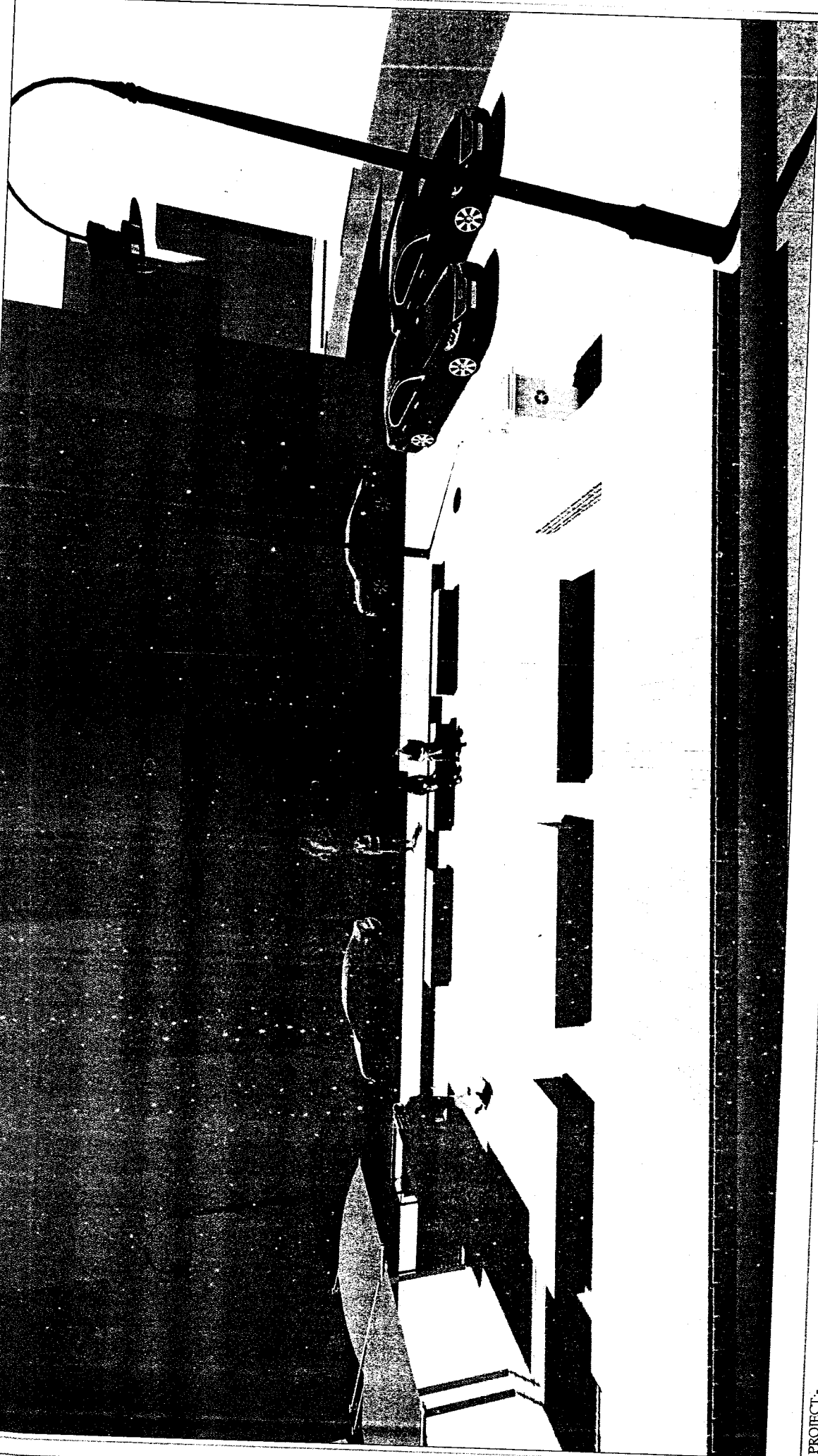

PROJECT:-

VENDING ZONE -
BORING CANAL ROAD
HARTALI MORE TO
RAJAPUR PUL.

SHEET TITLE:-

VIEW

CLIENT:-

PATNA
MUNICIPAL
CORPORATION,
PATNA.

DATE:-

17-07-2018

SHEET NO.:-

A -04

NORTH:-

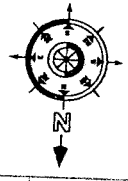

ARCHITECTS:-

100 - B, Pailputra colony, Cpd. P & M Mall,
Near Notre Dame Academy, Patna 80073
Tel / Fa x: 2287175 / 2275493
Email: contact@k Kapoor's.biz . Web: WWW.KKapoor's.Biz

k&a

Kapoor and associates

ARCHITECTURE | INTERIOR DESIGN | URBAN DESIGN

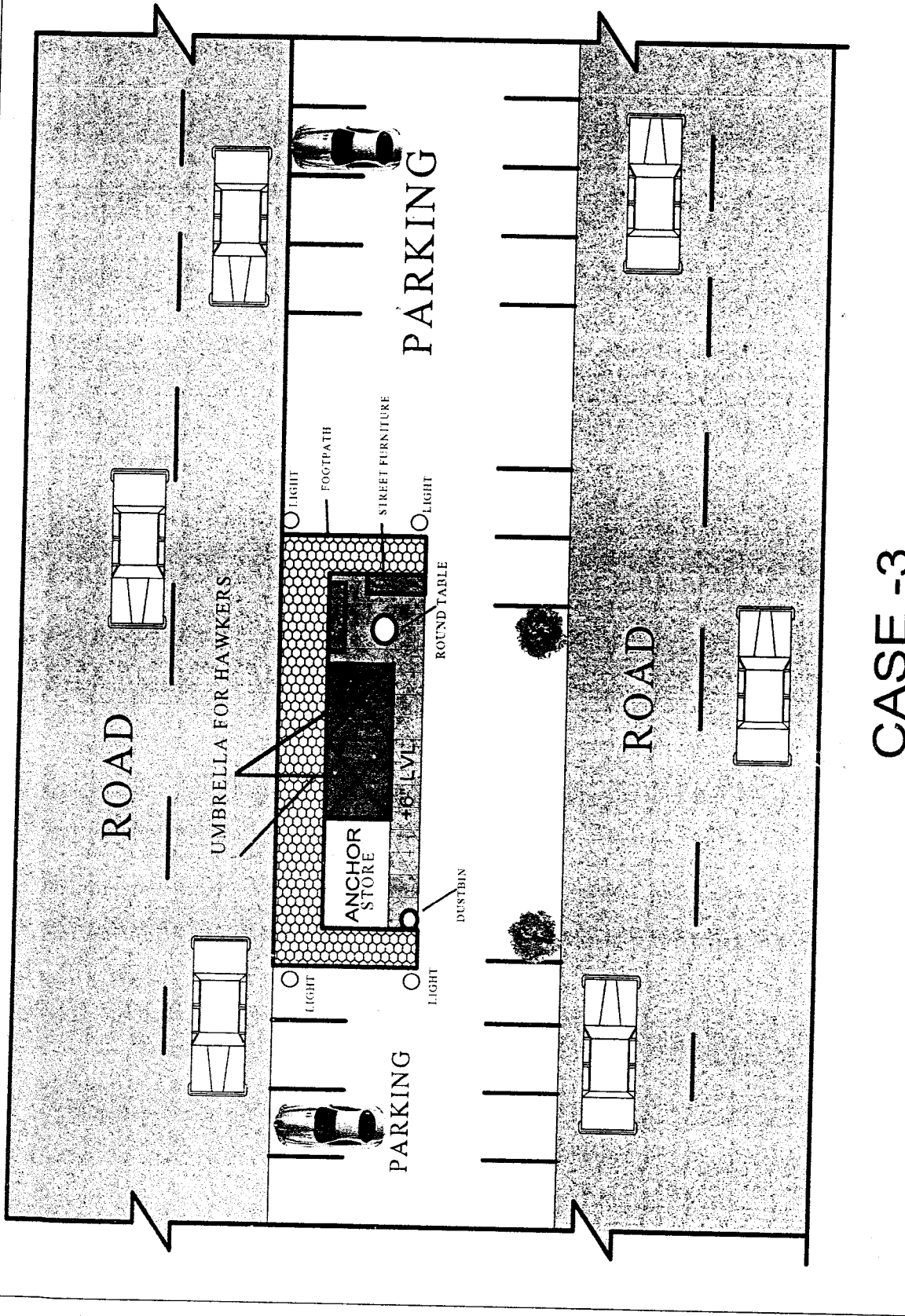

CASE -3

PROJECT:-

VENDING ZONE -
BORING CANAL ROAD
HARTALI MORE TO
RAJAPUR PUL.

SHEET TITLE:-

PLAN

CLIENT:-

PATNA
MUNICIPAL
CORPORATION,
PATNA.

DATE:-

17-07-2018

SHEET NO.:-

A -05

NORTH:-

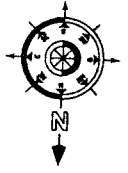

ARCHITECTS:-

100 - B, Peliputra colony, Opp. P & M Mall,
Near Notre Dame Academy, Patna 800013
Tel / Fa x: 2267175 / 2275824
Email: contact@k Kapoor's.biz . Web: WWW.K Kapoor's.Biz

k&a

Kapoor and associates
ARCHITECTURE | INTERIOR DESIGN | URBAN DESIGN

12/5

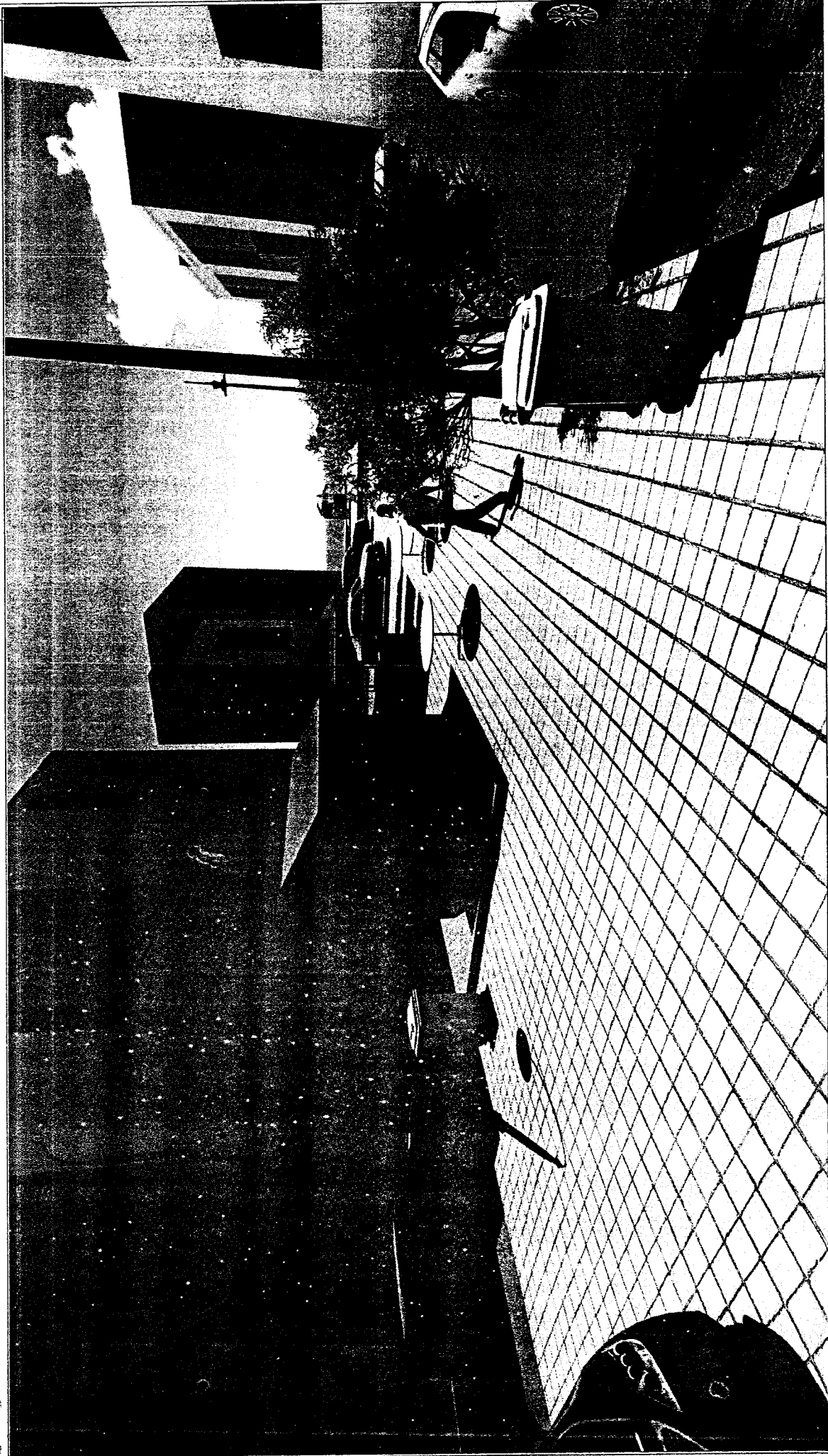

PROJECT:-

VENDING ZONE -
BORING CANAL ROAD
HARTALI MORE TO
RAJAPUR PUL.

SHEET TITLE:-

VIEW

CLIENT:-

PATNA
MUNICIPAL
CORPORATION,
PATNA.

DATE:-

17-07-2018

SHEET NO:-

A -06

NORTH:-

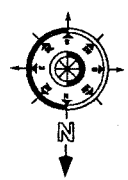

ARCHITECTS:-

100 - B, Paliputra colony, Opp P & M Mall,
Near Notre Dame Academy, Patna 800013
Tel / Fa x: 2287175 / 2275624
Email: contact@k Kapoor's.biz . Web: WWW.K Kapoor's.Biz

k&a

Kapoor and associates
ARCHITECTURE | INTERIOR DESIGN | URBAN DESIGN



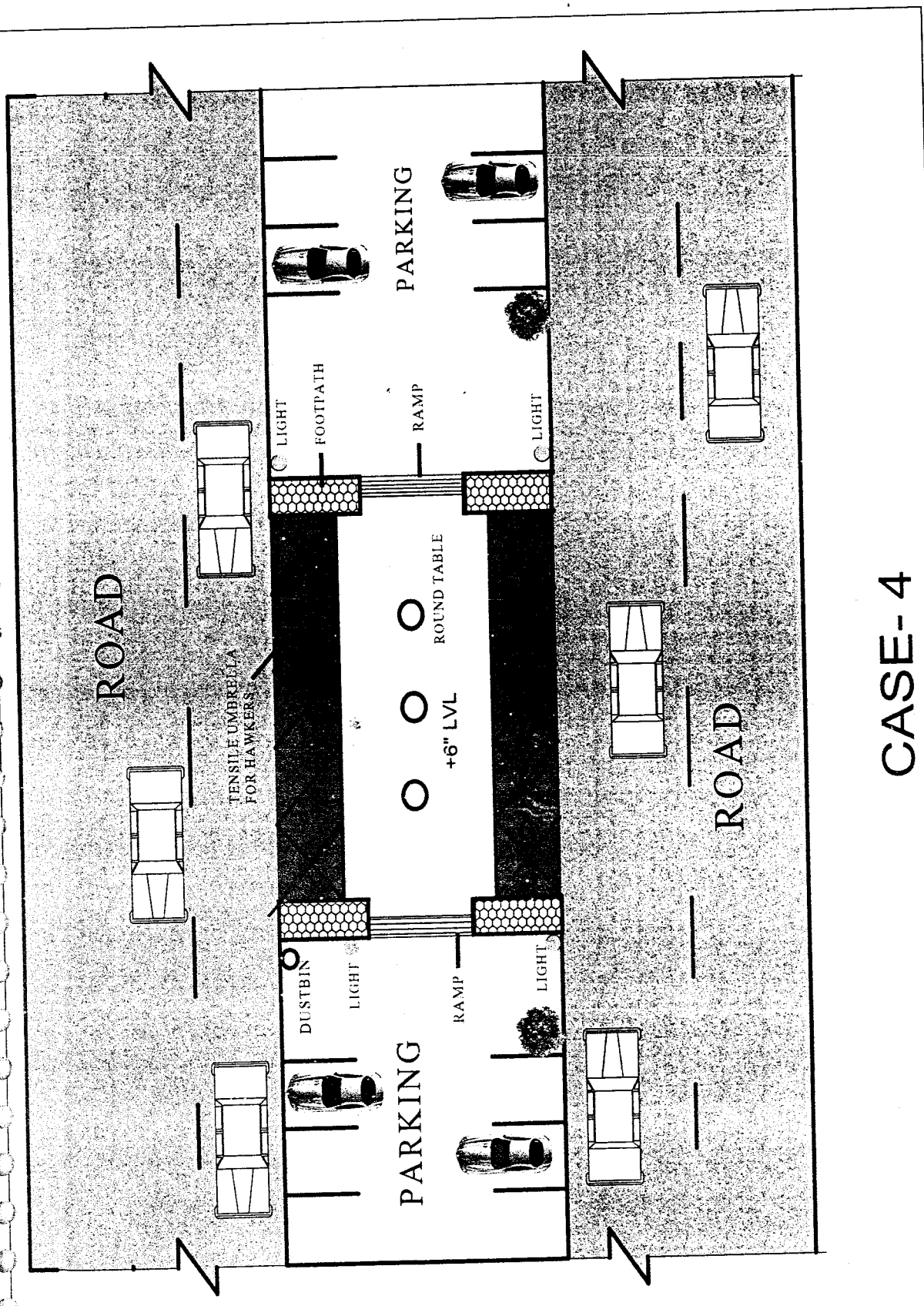

CASE-4

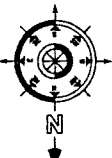
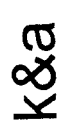
PROJECT:- VENDING ZONE - BORING CANAL ROAD HARTALI MORE TO RAJAPUR PUL.	SHEET TITLE:- PLAN	CLIENT:- PATNA MUNICIPAL CORPORATION, PATNA.	DATE:- 17-07-2018 SHEET NO:- A -07	NORTH:- 	ARCHITECTS:-  Kapor and associates ARCHITECTURE INTERIOR DESIGN URBAN DESIGN 100 - B, Patliputra colony, Opp. P & M Mall, Near New Dharma Academy, Patna 800013 Tel / Fa x: 2287175 / 2275824 Email: contact@kappoos.biz, Web: WWW.Kappoos.Biz
--	------------------------------	---	---	---	---

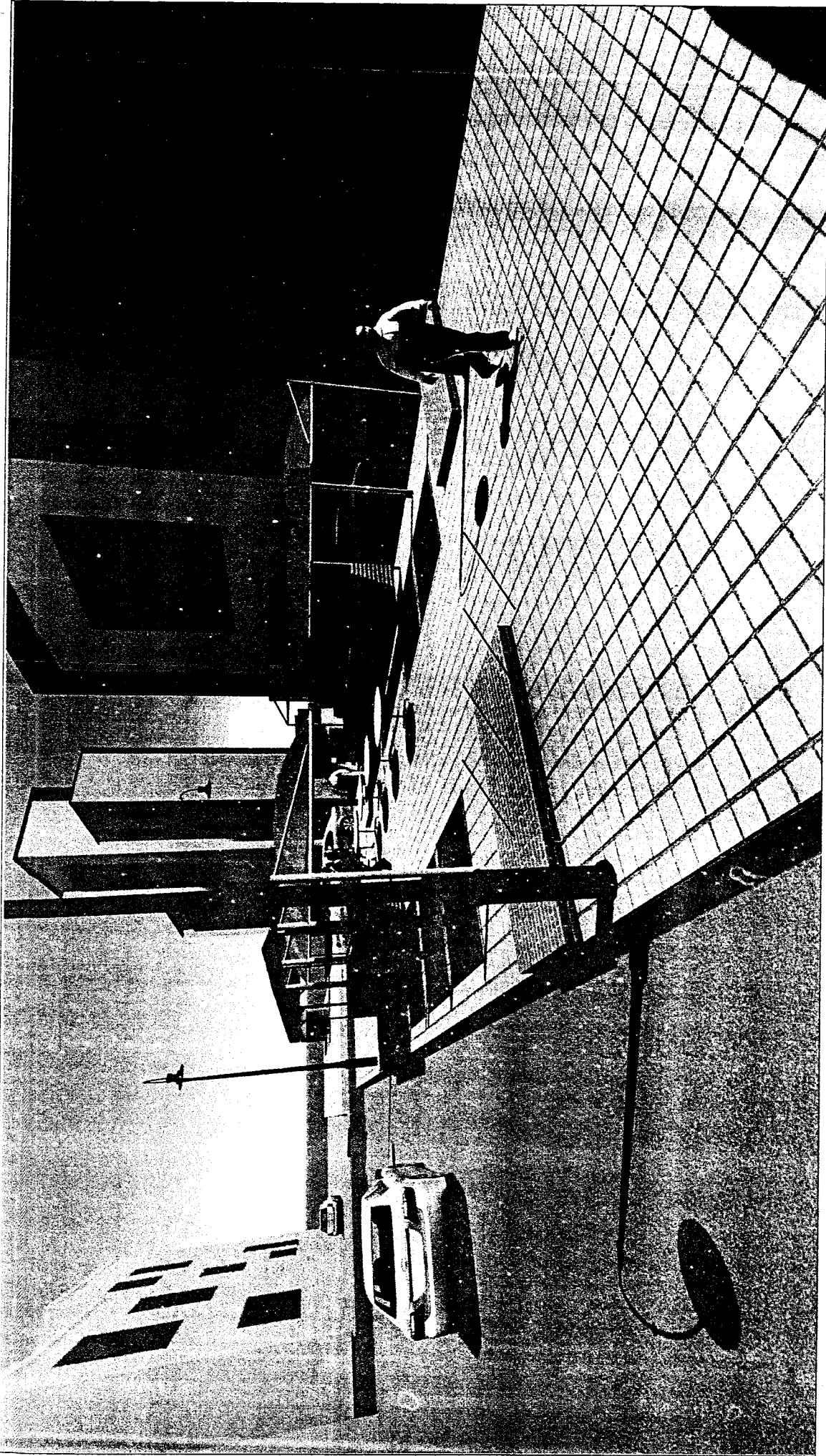

35

PROJECT:-

VENDING ZONE -
BORING CANAL ROAD
HARTALI MORE TO
RAJAPUR PUL.

SHEET TITLE:-

VIEW

CLIENT :-

PATNA
MUNICIPAL
CORPORATION,
PATNA.

DATE:-

17-07-2018

SHEET NO.:-

A -08

NORTH:-

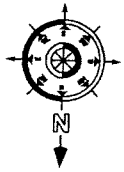

ARCHITECTS :-

100 - B. Pailpura colony . Opp. P. & M Mall,
Near Notre Dame Academy, Patna 800013
Tel / Fa x: 2267175 / 2275624
Email: contact@kapoors.biz . Web: WWW.Kapoors.Biz



k&a

Kapoor and associates

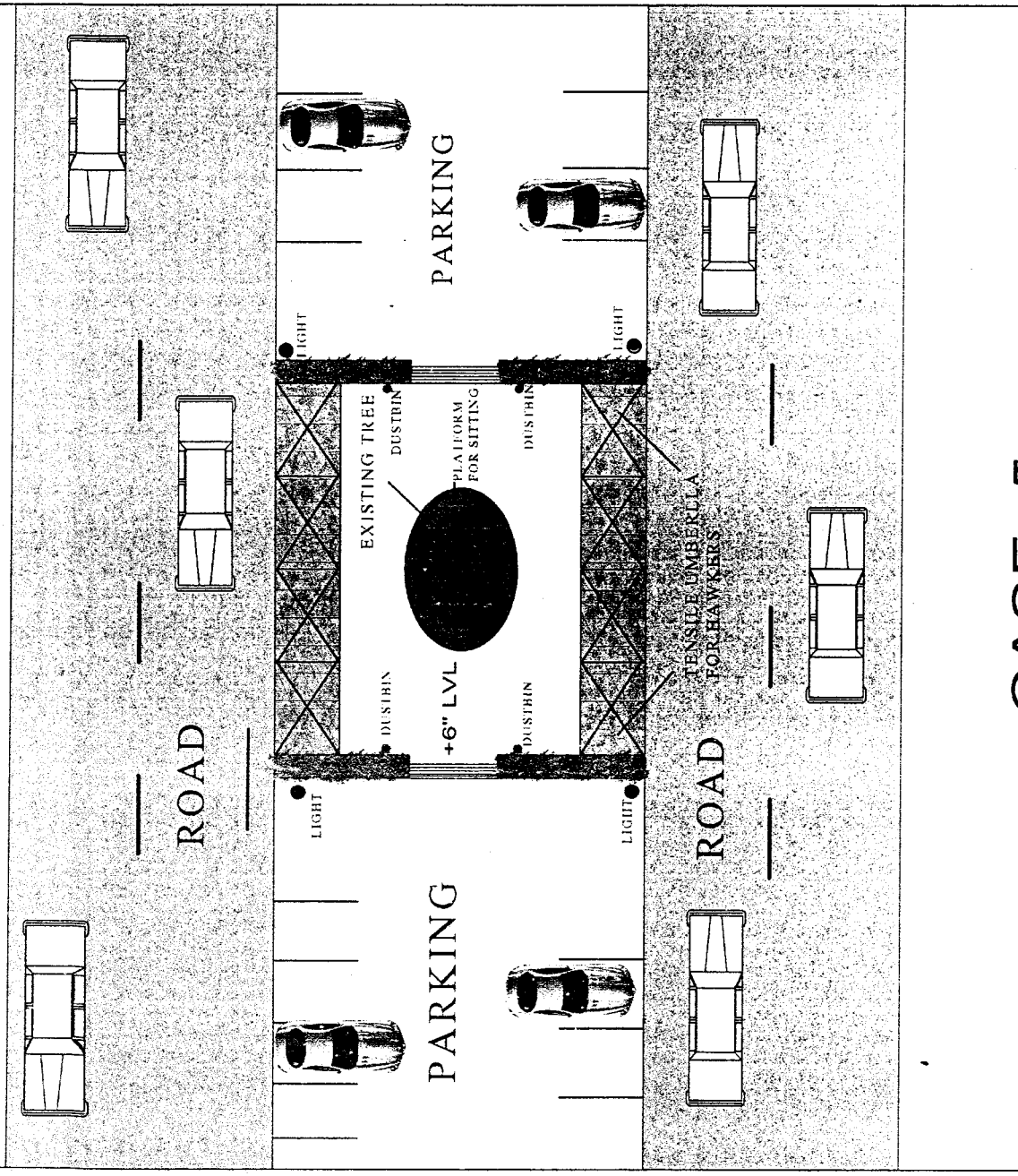
ARCHITECTURE | INTERIOR DESIGN | URBAN DESIGN

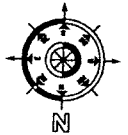

CASE- 5

PROJECT:- VENDING ZONE - BORING CANAL ROAD HARTALI MORE TO RAJAPUR PUL.	SHEET TITLE:- PLAN	CLIENT :- PATNA MUNICIPAL CORPORATION, PATNA.	DATE:- 17-07-2018 SHEET NO.: A -09	NORTH:- 	ARCHITECTS :- 	100 - B, Patliputra colony, Opp. P. & M Mall, Near Notre Dame Academy, Patna 800013 Tel / Fa. x: 2287175 / 2275824 Email: contact@k Kapoor's.biz . Web: WWW.K Kapoor's.Biz k&a Kapoor and associates ARCHITECTURE INTERIOR DESIGN URBAN DESIGN
--	------------------------------	--	---	---	--	---

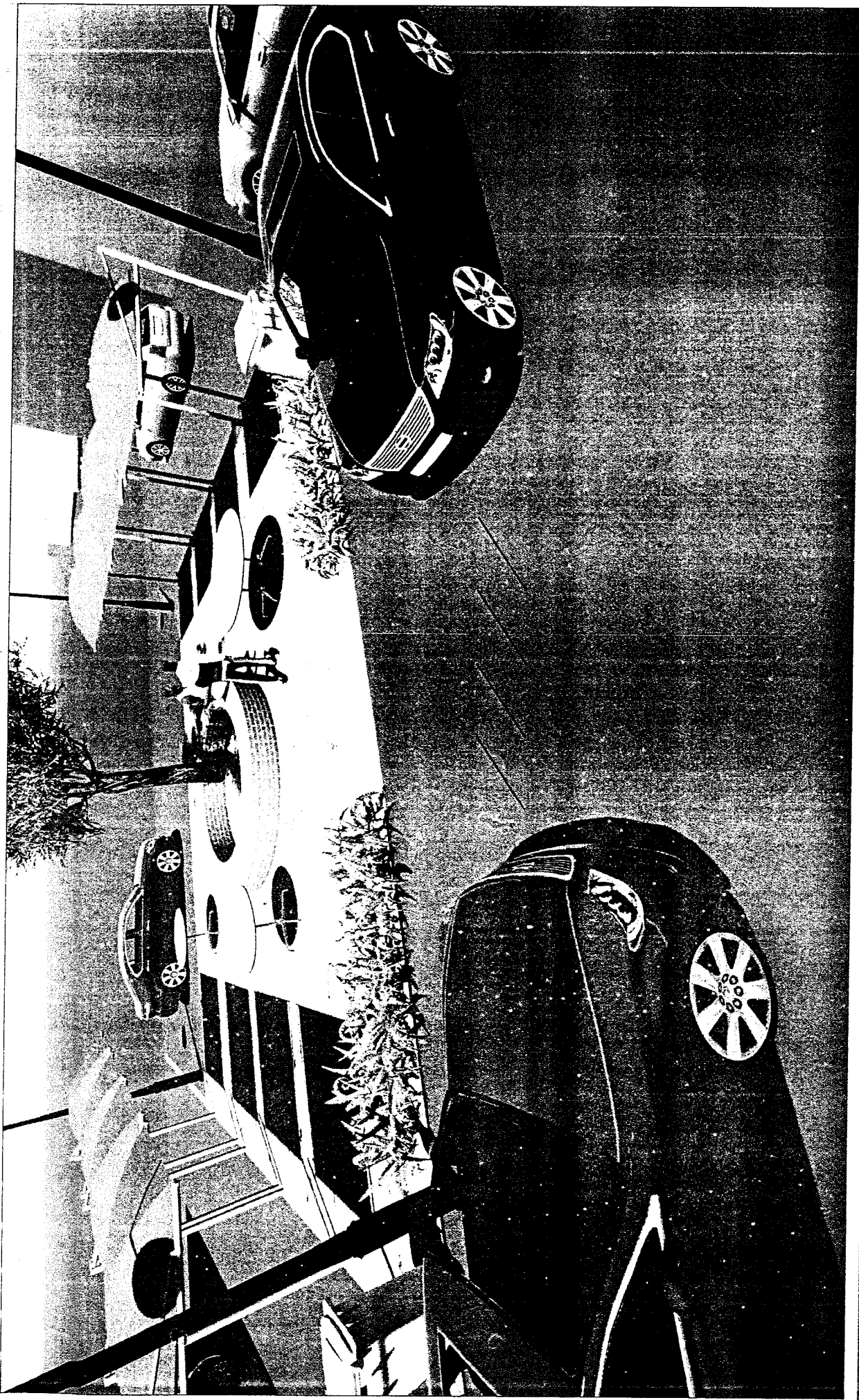

PROJECT:-

VENDING ZONE -
BORING CANAL ROAD
HARTALI MORE TO
RAJAPUR PUL.

SHEET TITLE:-

VIEW

CLIENT:-

PATNA
MUNICIPAL
CORPORATION,
PATNA.

DATE:-

17-07-2018

SHEET NO:-

A -10

NORTH:-

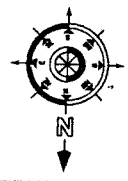

ARCHITECTS:-

100 - B, Patliputra colony, Opp. P & M Mall,
Near Notre Dame Academy, Patna 800013
Tel / Fa x: 2287175 / 2275924
Email: contact@k Kapoor's.biz . Web: WWW.K Kapoor's Biz

k&a

Kapoor and associates
ARCHITECTURE | INTERIOR DESIGN | URBAN DESIGN

3/9

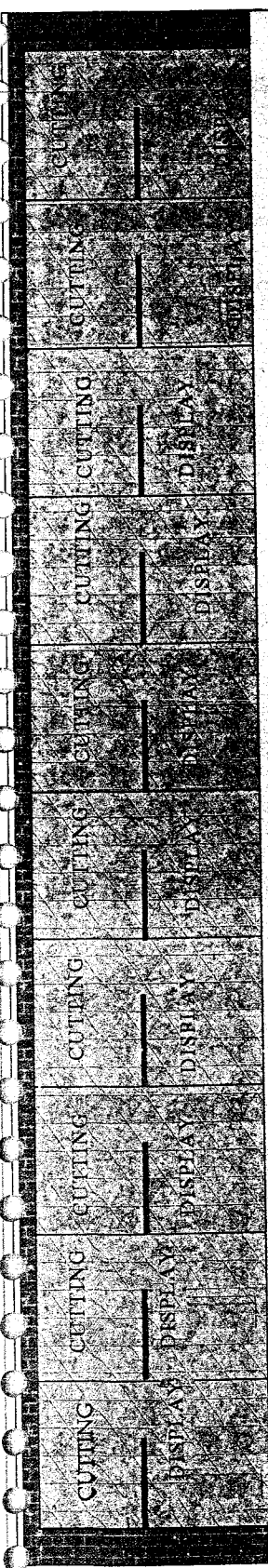

MEAT VENDING ZONE

1/1 = 9+

TENSILE STRUCTURE ON ROOF

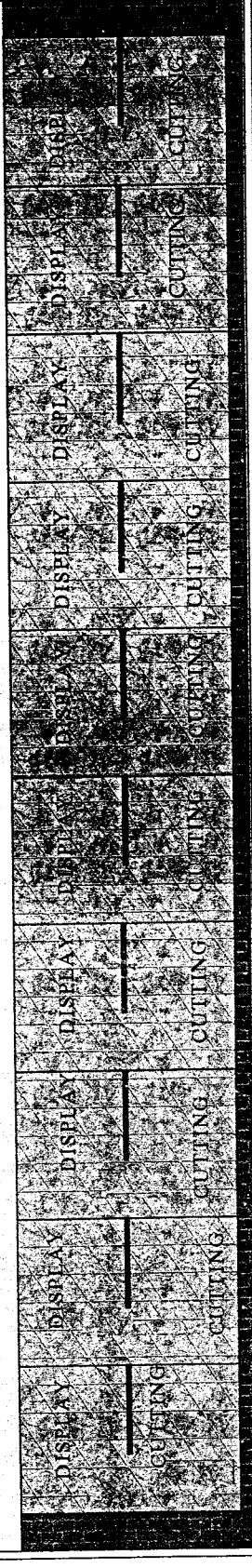

MEAT VENDING ZONE

PROJECT:-
**VENDING ZONE -
 BORING CANAL ROAD
 HARTALI MORE TO
 RAJAPUR PUL.**

SHEET TITLE:-
PLAN

CLIENT:-
**PATNA
 MUNICIPAL
 CORPORATION,
 PATNA.**

DATE:-
17-07-2018
 SHEET NO:-
A -11

NORTH:-

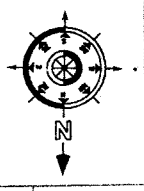



ARCHITECTS:-

k&a
 Kapoor and associates
 ARCHITECTURE | INTERIOR DESIGN | URBAN DESIGN

20

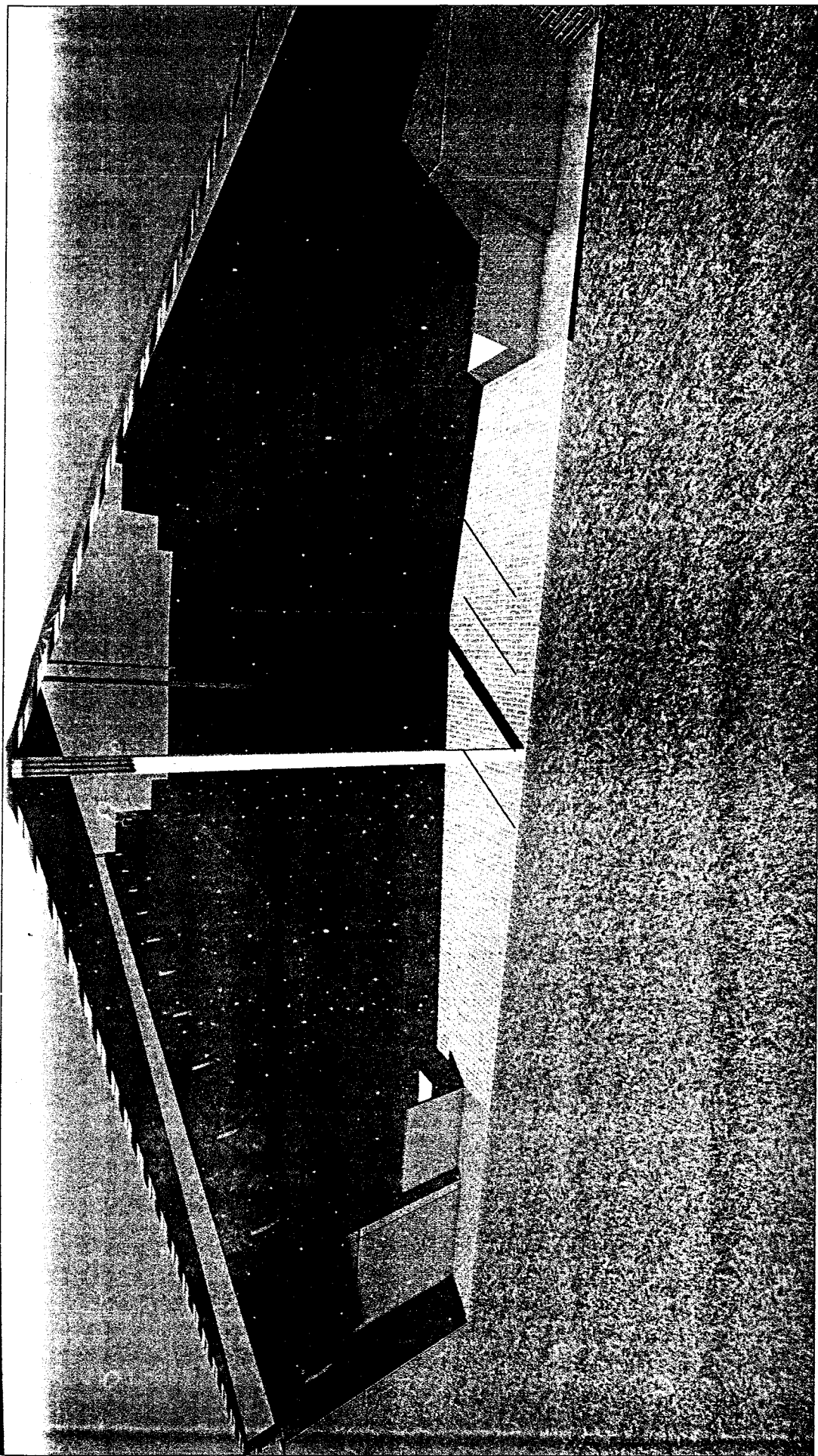
307

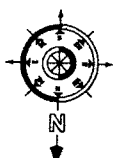

PROJECT:- VENDING ZONE - BORING CANAL ROAD HARTALI MORE TO RAJAPUR PUL.	SHEET TITLE:- VIEW	CLIENT:- PATNA MUNICIPAL CORPORATION, PATNA.	DATE:- 17-07-2018 SHEET NO:- A -12	NORTH:- 	ARCHITECTS:-  Kapoor and associates ARCHITECTURE INTERIOR DESIGN URBAN DESIGN
--	------------------------------	---	---	---	--

100 - B, Patliputra colony - Opp. P & M Mall,
 Near Nore Dinesh Academy, Patna 800013
 Tel: No. 91 951 751 2275524
 Email: contact@kapoorbiz . Web: WWW.KapoorBiz

206

K A P O O R A N D A S S O C I A T E S

Ravi Kapoor B.Arch, Chd, M.Arch, IIT-KGP, M.Arch & U.D Washington Univ. USA
 Kishore Kapoor B.Arch(Hons) chd. M.Arch, Univ. of Illinois, USA
 Vineeta Kapoor B.Arch (Hons) Chandigarh
 Anupama Kapoor B.Arch, Chandigarh

Architects, Engineers, Computer-Aided Design
 100B, Patliputra Colony, Near Notre Dame Academy
 Opposite P&M Mall, Patna-800 013
 Tel: 0612-2267175, Fax: 0612-2275624

Email: contact@kapoors.biz

REF:PMC/0034/2018		August 2nd, 2018		
VENDING ZONE				
PATNA MUNICIPAL CORPORATION, PATNA				
CONSULTANTS: KAPOOR AND ASSOCIATES				
2 NOS. OF MEAT VENDING ZONES / 18 HAWKERS = 36 HAWKERS				
2 NOS. OF VEGETABLE VENDING ZONES X 36 HAWKERS = 72 HAWKERS				
38 NOS. OF NORMAL VENDING ZONES X 12 HAWKERS = 456 HAWKERS				
TOTAL NO. OF HAWKERS = 564 HAWKERS				
SL.NO	LOCATION	USE	AS/NASVI	PROVIDED IN PROPOSAL
1	RAJAPOL MANDI	ON FLOOR FRUITS / VEG.	68	72(2 nos.) OF 36 EACH
2	BORING ROAD MACHLI MANDI	MEAT / FISH CHICKEN VENDORS	28	36 (2 NOS.) OF 18 EACH
3	BORING CANAL ROAD CROSSING BORING ROAD CROSSING	FRUITS-3 COBBLER-1 VEG. CART-2 TEA SHOP-1	7	12(1 NO.) OF 12 EACH
4	TEMPLE CROSSING SUDHA BOOTH CROSSING	FLOWERS-7 VEG.-3	7 3	12(1 NO.) OF 12 EACH
5	CROSSING SUDHA BOOTH CROSSING NEAR TOILET CROSSING NEAR PARATHAWALA GORAKHNATH NAV JYOTI TEMPLE NEAR GORAKHNATH	CHICKEN LITTI-1 SALOON-1 PAN SHOP-1 VEGETABLES-2 PAN SHOP-1 MOVABLE-8 PAN-1	15	12(1 NO.) OF 12 EACH
6	IN FRONT OF KUMAR TOWER	SNACKS PAN LITTI COBBLER	19	24 (2 NOS.) OF 12 EACH
7	NEAR PANT BHAWAN AJEET TYPE INDIRA BHAWAN	SNACKS PAN LITTI COBBLER	4+1+18	24 (2 NOS.) OF 12 EACH
8	NEAR BATA SHOWROOM	VEG. TEA CYCLE REPAIR	9	12(1 NO.) OF 12 EACH
9	NEAR BIG BAZAAR	VEG / FRUITS / EGG	14	12(1 NO.) OF 12 EACH
10	NEAR CHANDAN SWEETS	SNACKS / JUICE	7	12(1 NO.) OF 12 EACH
11	NEAR CHHAPPAN BHOG NEAR DAINIK BHASKAR NEAR DEV MEDICO	FRUITS VEG MOBILE COVER SNACKS	12	12(2 NO.) OF 6 EACH
12	NEAR DEVRANI JETHANI		16	
13	NEAR HDFC		9	24 (3 NOS.) OF 8 EACH
14	NEAR JANAK PLAZA ICICI INDIA TV		9	12(1 NO.) OF 12 EACH



दिनांक : 26.07.2018

सेवा में,

TVC अध्यक्ष सह नगर आयुक्त
पटना नगर निगम
पटना

विषय: NASVI द्वारा बोरिंग कैनाल रोड स्थित फूटपाथ दुकानदारों के सर्वेक्षण एवं डेटा अग्रसर कार्यवाही हेतु जमा करने के सम्बंध में

महाशय,

श्रीमान के निर्देशानुसार नासवी ने पटना नगर निगम क्षेत्रान्तर्गत बोरिंग कैनाल रोड स्थित फूटपाथ दुकानदारों का सर्वेक्षण किया है। जिसमें लगभग 449 फूटपाथ दुकानदारों का ऑन-स्पॉट सर्वेक्षण नासवी(NASVI) द्वारा किया गया जिस डेटा का एक्सेल एंट्री रिपोर्ट आपके आदेशानुसार कपूर एंड एसोसिएट्स नामक संस्था को हार्ड कॉपी प्रिंटआउट तथा ईमेल/पेन/CD ड्राइव के माध्यम से समर्पित किया गया है। तथा डेटा की प्रतिलिपि अग्रसर कार्यवाही हेतु नगर निगम में भी समर्पित किया गया है।

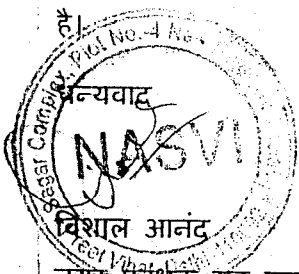

नगर प्रबंधक सह पटना प्रभारी

नासवी (नेशनल एसोसिएशन ऑफ स्ट्रीट वेंडर्स ऑफ इंडिया)

मोबाइल- 07004386107

संलग्न- 449 फूटपाथ दुकानदारों का सर्वेक्षण डेटा का एक्सेल एंट्री रिपोर्ट एवं हार्ड कॉपी प्रिंटआउट तथा ईमेल/पेन/CD के माध्यम से समर्पित किया गया

प्रतिलिपि: कपूर एंड एसोसिएट्स, 100-B, Patliputra Colony, Patna

S#	NAME	SELLING ITEM	VENDING MODE	AREA	LOCATION
1	DEEPAK DAS	COBLER	ON FLOOR	BORING CANAL ROAD CROSSING	BORING CANAL ROAD
2	MANISH KUMAR	FRUITS	CART	BORING CANAL ROAD CROSSING	BORING CANAL ROAD
3	RAJEEV RANJAN KUMAR	FRUITS	CART	BORING CANAL ROAD CROSSING	BORING CANAL ROAD
4	RAJESH KUMAR	FRUITS	CART	BORING CANAL ROAD CROSSING	BORING CANAL ROAD
5	RAVINDRA SAO	VEGETABLES	STALL	BORING CANAL ROAD CROSSING	BORING CANAL ROAD
6	ANIL KUMAR	VEGETABLES	STALL	BORING CANAL ROAD-BANSURIWALA	BORING CANAL ROAD
7	RAJEEV KUMAR	TEA SHOP	CART	BORING ROAD CROSSING-TOILET	BORING CANAL ROAD
8	AMIT KUMAR/BACHCHU SAHNI	FISH	SATLL	BORING ROAD MACHHLI MANDI	BORING CANAL ROAD
9	ANIL SAHNI	FISH	SATLL	BORING ROAD MACHHLI MANDI	BORING CANAL ROAD
10	GANGA SAHNI	FISH	SATLL	BORING ROAD MACHHLI MANDI	BORING CANAL ROAD
11	KRISHINA PASWAN	FISH	SATLL	BORING ROAD MACHHLI MANDI	BORING CANAL ROAD
12	MALTI DEVI	FISH	SATLL	BORING ROAD MACHHLI MANDI	BORING CANAL ROAD
13	MD. HASSAN	FISH	SATLL	BORING ROAD MACHHLI MANDI	BORING CANAL ROAD
14	SARASWATI DEVI	FISH	SATLL	BORING ROAD MACHHLI MANDI	BORING CANAL ROAD
15	SHIVSHANKAR MAHTO	FISH	SATLL	BORING ROAD MACHHLI MANDI	BORING CANAL ROAD
16	SURENDRA SAHNI	FISH	SATLL	BORING ROAD MACHHLI MANDI	BORING CANAL ROAD
17	VIKKI KUMAR	FISH	STALL	BORING ROAD MACHHLI MANDI	BORING CANAL ROAD
18	DILSHER	CHICKEN	STALL	BORING ROAD MEAT MANDI	BORING CANAL ROAD
19	MD BADRUDDIN	CHICKEN	STALL	BORING ROAD MEAT MANDI	BORING CANAL ROAD
20	MD ZIAUL HAQUE	CHICKEN	STALL	BORING ROAD MEAT MANDI	BORING CANAL ROAD
21	FIROZ	MEAT	SATLL	BORING ROAD MEAT MANDI	BORING CANAL ROAD
22	MANOVAR QURESHI	MEAT	SATLL	BORING ROAD MEAT MANDI	BORING CANAL ROAD
23	MD RASHID	MEAT	SATLL	BORING ROAD MEAT MANDI	BORING CANAL ROAD
24	MD. ABDUL QURESHI	MEAT	SATLL	BORING ROAD MEAT MANDI	BORING CANAL ROAD
25	MD. AFTAB	MEAT	SATLL	BORING ROAD MEAT MANDI	BORING CANAL ROAD
26	MD. BADRUDDIN QURESHI	MEAT	SATLL	BORING ROAD MEAT MANDI	BORING CANAL ROAD
27	MD. MUBARAK	MEAT	SATLL	BORING ROAD MEAT MANDI	BORING CANAL ROAD
28	MD. MUSTAFA	MEAT	SATLL	BORING ROAD MEAT MANDI	BORING CANAL ROAD
29	MD. RIZWAN QURESHI	MEAT	SATLL	BORING ROAD MEAT MANDI	BORING CANAL ROAD
30	MD. SHAHBUDDIN	MEAT	SATLL	BORING ROAD MEAT MANDI	BORING CANAL ROAD
31	MD. SONI	MEAT	SATLL	BORING ROAD MEAT MANDI	BORING CANAL ROAD
32	MD. SULTAN	MEAT	SATLL	BORING ROAD MEAT MANDI	BORING CANAL ROAD
33	NIZAM	MEAT	SATLL	BORING ROAD MEAT MANDI	BORING CANAL ROAD
34	SHAHZAD ALAM	MEAT	SATLL	BORING ROAD MEAT MANDI	BORING CANAL ROAD
35	MD. TASLEEM	MEAT/CHICKEN	STALL	BORING ROAD MEAT MANDI	BORING CANAL ROAD
36	PRAKASH KUMAR	PAN SHOP	GUMTI	CORSSING SUDHA BOOTH	BORING CANAL ROAD
37	LALTI DEVI	VEGETABLES	TOKRI	CORSSING SUDHA BOOTH	BORING CANAL ROAD
38	PARMILA DEVI	VEGETABLES	TOKRI	CORSSING SUDHA BOOTH	BORING CANAL ROAD
39	RAMBACHCHAN PD	VEGETABLES	TOKRI	CORSSING SUDHA BOOTH	BORING CANAL ROAD
40	DURGA PD	CHICKEN LITTI	CART	CROSSING NEAR TOILET	BORING CANAL ROAD
41	GIRDHAR GOPAL SHARMA	SALOON	CHAIR	CROSSING NEAR TOILET	BORING CANAL ROAD
42	GUDDU MALI	FLOWER	ON FLOOR/STALL	CROSSING TEMPLE	BORING CANAL ROAD
43	MANISH KUMAR	FLOWER	ON FLOOR/STALL	CROSSING TEMPLE	BORING CANAL ROAD
44	MANOJ KUMAR	FLOWER	ON FLOOR/STALL	CROSSING TEMPLE	BORING CANAL ROAD
45	RAMESHWAR BHAGAT	FLOWER	ON FLOOR/STALL	CROSSING TEMPLE	BORING CANAL ROAD

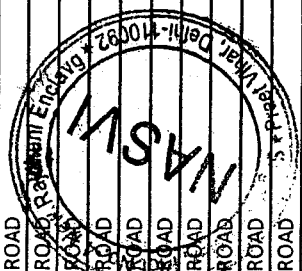

S#	NAME	SELLING ITEM	VENDING MODE	AREA	LOCATION
46	RAVI SHANKAR	FLOWER	ON FLOOR/STALL	CROSSING TEMPLE	BORING CANAL ROAD
47	SHIV PD	FLOWER	ON FLOOR/STALL	CROSSING TEMPLE	BORING CANAL ROAD
48	SURENDRA MALI	FLOWER	ON FLOOR/STALL	CROSSING TEMPLE	BORING CANAL ROAD
49	JNDU DEVI	VEGETABLES	ON FLOOR/STALL	CROSSINGNEAR PARATHA WALA	BORING CANAL ROAD
50	OM BIND	VEGETABLES	ON FLOOR/STALL	CROSSINGNEAR PARATHA WALA	BORING CANAL ROAD
51	SANJAY MAHTO	PAN SHOP	GUMTI	GORAKH NATH -NAVYOTI TEMPLE	BORING CANAL ROAD
52	KRISHNA SAO	FASTFOOD	CART	INFRONT OF KUMAR TOWER-PARKING	BORING CANAL ROAD
53	LAKSHMI KUMAR	FASTFOOD	CART	INFRONT OF KUMAR TOWER-PARKING	BORING CANAL ROAD
54	SANOJ KUMAR	FASTFOOD	STALL	INFRONT OF KUMAR TOWER-PARKING	BORING CANAL ROAD
55	VINOD KUMAR	FASTFOOD	STALL	INFRONT OF KUMAR TOWER-PARKING	BORING CANAL ROAD
56	RAMLAKHAN PANDIT	MITTI-POT	ON FLOOR	INFRONT OF KUMAR TOWER-PARKING	BORING CANAL ROAD
57	BIHARI SAO	PAN SHOP	GUMTI	INFRONT OF KUMAR TOWER-PARKING	BORING CANAL ROAD
58	DINANATH RAM	PAN SHOP	GUMTI	INFRONT OF KUMAR TOWER-PARKING	BORING CANAL ROAD
59	RAMAKANT PANDEY	PAN SHOP	GUMTI	INFRONT OF KUMAR TOWER-PARKING	BORING CANAL ROAD
60	RAVINDRA PRASAD	PAN SHOP	GUMTI	INFRONT OF KUMAR TOWER-PARKING	BORING CANAL ROAD
61	ANAND KUMAR	PAN SHOP	PAN STALL	INFRONT OF KUMAR TOWER-PARKING	BORING CANAL ROAD
62	BANS LAL PANJIYAR	SNACKS- PARATHA	CART	INFRONT OF KUMAR TOWER-PARKING	BORING CANAL ROAD
63	VIJAY KUMAR	SNACKS-CHHOLE BHATURE	CART	INFRONT OF KUMAR TOWER-PARKING	BORING CANAL ROAD
64	KUNAL ANAND	SNACKS-CHICKEN PAKODA	CART	INFRONT OF KUMAR TOWER-PARKING	BORING CANAL ROAD
65	AWADH KUMAR	SNACKS-DOSA	CART	INFRONT OF KUMAR TOWER-PARKING	BORING CANAL ROAD
66	DINESH KUMAR	SNACKS-LITTI	CART	INFRONT OF KUMAR TOWER-PARKING	BORING CANAL ROAD
67	MANGAL SINGH	SNACKS-LITTI	CART	INFRONT OF KUMAR TOWER-PARKING	BORING CANAL ROAD
68	DHARMENDRA KUMAR	SNACKS-PARATHA	CART	INFRONT OF KUMAR TOWER-PARKING	BORING CANAL ROAD
69	ARJUN SAO	TEA SHOP	CART	INFRONT OF KUMAR TOWER-PARKING	BORING CANAL ROAD
70	KAMESHWAR	TEA SHOP	CART	INFRONT OF KUMAR TOWER-PARKING	BORING CANAL ROAD
71	SURESH SAH	FRUIT-JUICE	CART	MOVABLE	BORING CANAL ROAD
72	PREM KUMAR	ICECREAM-CART	CART	MOVABLE	BORING CANAL ROAD
73	PREM NARAYAN	ICECREAM-CART	CART	MOVABLE	BORING CANAL ROAD
74	SHOP CLOSED DURING SURVEY	ICECREAM-CART	CART	MOVABLE	BORING CANAL ROAD
75	RAMU	JUICE-SUGAN CANE	CART	MOVABLE	BORING CANAL ROAD
76	KRISHNA	SNACKS-BURGER	CART	MOVABLE	BORING CANAL ROAD
77	SUKESH KUMAR	SNACKS-GOLGAPPA	CART	MOVABLE	BORING CANAL ROAD
78	SUNIL DAS	SNACKS-GOLGAPPA	CART	MOVABLE	BORING CANAL ROAD
79	VINOD KUMAR	SNACKS-SAMOSA	CART	MOVABLE	BORING CANAL ROAD
80	RAHUL	PAN SHOP	TABLE	NEAR AJEET TYRE	BORING CANAL ROAD
81	GAJRA DEVI	SNACKS-LITTI	GUMTI	NEAR AJIT PHOTO COPY, PANT BHAWAN	BORING CANAL ROAD
82	SATNAR	BICYCLE REPAIR	CART	NEAR AJIT PHOTO COPY, PANT BHAWAN	BORING CANAL ROAD
83	PARAMESHWAR RAY	TEA SHOP	TABLE	NEAR BATA SHOW ROOM	BORING CANAL ROAD
84	ARVIND MANDAL	VEGETABLES	CART	NEAR BATA SHOW ROOM	BORING CANAL ROAD
85	AJAY KUMAR	VEGETABLES	CART	NEAR BATA SHOW ROOM	BORING CANAL ROAD
86	ARUNA DEVI	VEGETABLES	ONFLOOR/CART	NEAR BATA SHOW ROOM	BORING CANAL ROAD
87	OM PRAKASH	VEGETABLES	ONFLOOR/CART	NEAR BATA SHOW ROOM	BORING CANAL ROAD
88	RAMAN KUMAR	VEGETABLES	ONFLOOR/CART	NEAR BATA SHOW ROOM	BORING CANAL ROAD
89	SURAJ MAHTO	VEGETABLES	ONFLOOR/CART	NEAR BATA SHOW ROOM	BORING CANAL ROAD
90	SUTENDAR	VEGETABLES	ONFLOOR/CART	NEAR BATA SHOW ROOM	BORING CANAL ROAD



30

S#	NAME	SELLING ITEM	VENDING MODE	AREA	LOCATION
91	AMIT KUMAR	FRUITS	CART	NEAR BIGBAZAAR	BORING CANAL ROAD, RAJAPUL
92	HIRALAL	FRUITS	CART	NEAR BIGBAZAAR	BORING CANAL ROAD, RAJAPUL
93	JAWAHARLAL GUPTA	FRUITS	CART	NEAR BIGBAZAAR	BORING CANAL ROAD, RAJAPUL
94	MULCHAND RAM	FRUITS	CART	NEAR BIGBAZAAR	BORING CANAL ROAD, RAJAPUL
95	MD. MOIN KHAN	SNACKS-EGG	CART	NEAR BIGBAZAAR	BORING CANAL ROAD, RAJAPUL
96	ASHOK KUMAR	VEGETABLES	CART	NEAR BIGBAZAAR	BORING CANAL ROAD, RAJAPUL
97	ATENDAR SAO	VEGETABLES	CART	NEAR BIGBAZAAR	BORING CANAL ROAD, RAJAPUL
98	MUKESH KUMAR	VEGETABLES	CART	NEAR BIGBAZAAR	BORING CANAL ROAD, RAJAPUL
99	BHOLA SAH	VEGETABLES	ONFLOOR/CART	NEAR BIGBAZAAR	BORING CANAL ROAD, RAJAPUL
100	CHANCHAL DEVI	VEGETABLES	ONFLOOR/CART	NEAR BIGBAZAAR	BORING CANAL ROAD, RAJAPUL
101	JAWAR ALAM	VEGETABLES	ONFLOOR/CART	NEAR BIGBAZAAR	BORING CANAL ROAD, RAJAPUL
102	MUNNA SAO	VEGETABLES	ONFLOOR/CART	NEAR BIGBAZAAR	BORING CANAL ROAD, RAJAPUL
103	PAPPU SAO	VEGETABLES	ONFLOOR/CART	NEAR BIGBAZAAR	BORING CANAL ROAD, RAJAPUL
104	RANJEET SAO	VEGETABLES	ONFLOOR/CART	NEAR BIGBAZAAR	BORING CANAL ROAD, RAJAPUL
105	AJAY KUMAR SAH	JUICE	CART	NEAR CHANDAN SWEETS	BORING CANAL ROAD
106	SANJAY KUMAR SAH	JUICE	CART	NEAR CHANDAN SWEETS	BORING CANAL ROAD
107	ANAJ KUMAR	PAN SHOP	GUMTI	NEAR CHANDAN SWEETS	BORING CANAL ROAD
108	DHANANJAY KUMAR	SNACKS/CHOWMEIN	CART	NEAR CHANDAN SWEETS	BORING CANAL ROAD
109	VIKAS KUMAR	SNACKS/CHOWMEIN	CART	NEAR CHANDAN SWEETS	BORING CANAL ROAD
110	SONU KUMAR GUPTA	SNACKS/LITTI	CART	NEAR CHANDAN SWEETS	BORING CANAL ROAD
111	DILEEP KUMAR	SNACKS/MOMO	CART	NEAR CHANDAN SWEETS	BORING CANAL ROAD
112	SUSHEEL KUMAR	SNACKS/MOMO	CART	NEAR CHANDAN SWEETS	BORING CANAL ROAD
113	GOPAL	JUICE	CART	NEAR CHANDAN SWEETS	BORING CANAL ROAD
114	MUKESH KUMAR	VEGETABLES	ONFLOOR/CART	NEAR CHHAPPAN BHOG	BORING CANAL ROAD
115	SHIV SHANKAR	VEGETABLES	ONFLOOR/CART	NEAR CHHAPPAN BHOG	BORING CANAL ROAD
116	SURENDRA SAH	FRUITS	CART	NEAR CHHAPPAN BHOG	BORING CANAL ROAD
117	RAJU KUMAR	JUICE	CART	NEAR DAINIK BHASKAR	BORING CANAL ROAD
118	SAURABH MISTRA	MOBILE COVER	CART	NEAR DAINIK BHASKAR	BORING CANAL ROAD
119	PANKAJ KUMAR	PAN SHOP	TABLE	NEAR DAINIK BHASKAR	BORING CANAL ROAD
120	OM PRAKASH ROY	SNACKS-BHUNJA	GUMTI	NEAR DAINIK BHASKAR	BORING CANAL ROAD
121	CHANDAN KUMAR	FRUITS	CART	NEAR DAINIK BHASKAR	BORING CANAL ROAD
122	R.K SODA	JUICE/SODA	CART	NEAR DEV MEDICO	BORING CANAL ROAD
123	KISHOR SAH	SNACK-CHAT	VAN	NEAR DEV MEDICO	BORING CANAL ROAD
124	AJAY KUMAR	VEGETABLES	CART	NEAR DEV MEDICO	BORING CANAL ROAD RAJAPUL
125	VILAS MISTRI	VEGETABLES	CART	NEAR DEV MEDICO	BORING CANAL ROAD
126	AKHILESH KUMAR	BATTERY	ON FLOOR	NEAR DEVRANI JETHANI	BORING CANAL ROAD
127	AWDHESH KUMAR	PAN SHOP	BORING CANAL; ROAD	NEAR DEVRANI JETHANI	BORING CANAL ROAD
128	SIARAM	PAN SHOP	GUMTI	NEAR DEVRANI JETHANI	BORING CANAL ROAD
129	BHARAT SHARMA	SALOON	GUMTI	NEAR DEVRANI JETHANI	BORING CANAL ROAD
130	GULAB KUMAR	SNACKS-BATATPURI	CHAIR	NEAR DEVRANI JETHANI	BORING CANAL ROAD
131	BINOD KUMAR	SNACKS-BURGER	CART	NEAR DEVRANI JETHANI	BORING CANAL ROAD
132	VIKAS KUMAR	SNACKS-BURGER	CART	NEAR DEVRANI JETHANI	BORING CANAL ROAD
133	MUNCHUN DEVI	SNACKS-CHHOLE BHATURE	CART	NEAR DEVRANI JETHANI	BORING CANAL ROAD
134	JITENDAR PRASAD	SNACKS-EGG	CART	NEAR DEVRANI JETHANI	BORING CANAL ROAD
135	JAY KUMAR	SNACKS-FASTFOOD	CART	NEAR DEVRANI JETHANI	BORING CANAL ROAD

301

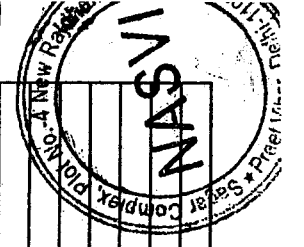

S#	NAME	SELLING ITEM	VENDING MODE	AREA	LOCATION
136	BABLU KUMAT	SNACKS-MOMO	CART	NEAR DEVRANI JETHANI	BORING CANAL ROAD
137	SHAMBHU SAH	SNACKS-MOMO	CART	NEAR DEVRANI JETHANI	BORING CANAL ROAD
138	RAM	TEA SHOP	CART	NEAR DEVRANI JETHANI	BORING CANAL ROAD
139	VISHESHWAR ROY	TEA SHOP	CART	NEAR DEVRANI JETHANI	BORING CANAL ROAD
140	LALIT KUMAR SAH	WELDING	CART	NEAR DEVRANI JETHANI	BORING CANAL ROAD
141	GUDDU KUMAR	PAN SHOP	GUMTI	NEAR GORAKH NATH	BORING CANAL ROAD
142	RAMAVATAR MAHTO	FRUITS	CART	NEAR HDFC BANK	BORING CANAL ROAD
143	SUMIT KUMAR	JUICE	CART	NEAR HDFC BANK	BORING CANAL ROAD
144	UMESH KUMAR PASWAN	SNACKS/BURGER	CART	NEAR HDFC BANK	BORING CANAL ROAD
145	UMESH SAH	SNACKS/MOMO	CART	NEAR HDFC BANK	BORING CANAL ROAD
146	RAMESH YADAV	SNACKS-EGG	CART	NEAR HDFC BANK	BORING CANAL ROAD
147	SHANKAR DAS	SNACKS-GOLGAPPA	CART	NEAR HDFC BANK	BORING CANAL ROAD
148	AVDESH GUPTA	TEA SHOP	CART	NEAR HDFC BANK	BORING CANAL ROAD
149	BHANU PRASAD	TEA SHOP	CART	NEAR HDFC BANK	BORING CANAL ROAD
150	RAJU KUMAR	VEGETABLES	ONFLOOR/CART	NEAR HDFC BANK	BORING CANAL ROAD
151	AJAY PD	SODA - JUICE	VAN	NEAR ICICI BANK	BORING CANAL ROAD
152	KESHAV BHAGAT	FLOWER	ON FLOOR	NEAR INDIA TV	BORING CANAL ROAD
153	RAKESH KUMAR	ICECREAM-CART	CART	NEAR INDIA TV	BORING CANAL ROAD
154	UMESH PRASAD MANDAL	SNACKS	CART	NEAR INDIRA BHAWAN -	BORING CANAL ROAD RAJAPOL
155	MANOJ KUMAR	FASTFOOD	CART	NEAR INDRAPRASTH	BORING CANAL ROAD
156	AJAY KUMAR	JUICE	CART	NEAR INDRAPRASTH	BORING CANAL ROAD
157	PRABHUN RAM	JUICE-BEL	CART	NEAR INDRAPRASTH	BORING CANAL ROAD
158	SAURABH KUMAR	JUICE-SUGAN CANE	CART	NEAR INDRAPRASTH	BORING CANAL ROAD
159	RAGHUVIR	SNACKS-BHUNJA	CART	NEAR INDRAPRASTH	BORING CANAL ROAD
160	SHIV SHANKAR	SNACKS-BURGER	CART	NEAR INDRAPRASTH	BORING CANAL ROAD
161	SONU KUMAR	SNACKS-BURGER	CART	NEAR INDRAPRASTH	BORING CANAL ROAD
162	SUNIL THAKUR	SNACKS-EGG	CART	NEAR INDRAPRASTH	BORING CANAL ROAD
163	MD. MOKIM	TAILOR	TABLE	NEAR INDRAPRASTH	BORING CANAL ROAD
164	SHEELA DEVI	VEGETABLES	ON FLOOR	NEAR INDRAPRASTH	BORING CANAL ROAD
165	BR1AD5953	COLD DRINK	VAN	NEAR INDRAPRASTHA	BORING CANAL ROAD
166	PUTUSH KUMAR	ICECREAM-CART	CART	NEAR INDRAPRASTHA	BORING CANAL ROAD
167	LOKESH	JUICE-SUGAN CANE	CART	NEAR INDRAPRASTHA	BORING CANAL ROAD
168	ABHIMANYU CHAURASIA	PAN SHOP	CART	NEAR INDRAPRASTHA	BORING CANAL ROAD
169	CHANDAN KUMAR	SNACKS/MOMO	CART	NEAR INDRAPRASTHA	BORING CANAL ROAD
170	JEEVAN KUMAR	FRUITS	STALL	NEAR JAGDISH LOK PARTMENT	BORING CANAL ROAD
171	RAMESH RAM	CLOTHES	CART	NEAR JANAK PLAZA	BORING CANAL ROAD
172	VIRENDRA	FRUITS	CART	NEAR JANAK PLAZA	BORING CANAL ROAD
173	GUDDU KUMAR	ICECREAM-CART	CART	NEAR JANAK PLAZA	BORING CANAL ROAD
174	SATYAM	MOBILE COVER	TABLE	NEAR JANAK PLAZA	BORING CANAL ROAD
175	BALAM BHARI/ARBIND RAY	SNACKS/LITTI	CART	NEAR JANAK PLAZA	BORING CANAL ROAD
176	RANJAN KUMAR	VEGETABLES	ONFLOOR/CART	NEAR JANAK PLAZA	BORING CANAL ROAD
177	ARIJUN KUMAR	PAN SHOP	CART	NEAR JINAM	BORING CANAL ROAD
178	SHANTI DEVI	TEA SHOP	CART	NEAR JINAM	BORING CANAL ROAD
179	MUKESH KUMAR	PAN SHOP	GUMTI	NEAR LALITA-HOTEL	BORING CANAL ROAD
180	SANJAY KUMAR	PAN SHOP	GUMTI	NEAR LALITA-HOTEL	BORING CANAL ROAD

13

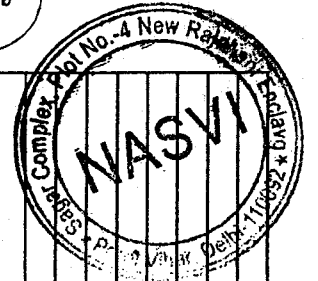

S#	NAME	SELLING ITEM	VENDING MODE	AREA	LOCATION
181	PRAKASH SAO	SNACKS-BHUNJA	CART	NEAR MAHADEV MAHTO MARG	BORING CANAL ROAD
182	NAGENDRA SAH	FRUITS	CART	NEAR MAHADEV MAHTO MARG	BORING CANAL ROAD-S K PURI CROSSING
183	SHANKAR KUMAR	SNACKS-BHUNJA	CART	NEAR MAHADEV MAHTO MARG	BORING CANAL ROAD-S K PURI CROSSING
184	SHOP CLOSED DURING SURVEY	FASTFOOD	STALL	NEAR MEDICANA	BORING CANAL ROAD
185	UDAY GUPTA	HELMET ACCESSORIES	CART	NEAR MEDICANA	BORING CANAL ROAD
186	KRISHNA PD	PUNCHAR MISTRI	ON FLOOR	NEAR MEDICANA	BORING CANAL ROAD
187	SAROJ PANIJAR	SNACKS-BURGER	CART	NEAR MEDICANA	BORING CANAL ROAD
188	RANJIT LAL	SNACKS-GOLGAPPA	CART	NEAR PAHALWAN MARKET	BORING CANAL ROAD
189	GOPAL JHA	BHELPURI	CART	NEAR PANCHMUKHI	BORING CANAL ROAD
190	VIKAS KUMAR	BHELPURI	CART	NEAR PANCHMUKHI	BORING CANAL ROAD
191	NAND LAL	COBBLER	ON FLOOR	NEAR PANCHMUKHI	BORING CANAL ROAD
192	UMA THAKUR	COBBLER	ON FLOOR	NEAR PANCHMUKHI	BORING CANAL ROAD
193	RANJIT KUMAR SINGH	FASTFOOD	CART	NEAR PANCHMUKHI	BORING CANAL ROAD
194	SAVITA DEVI	FASTFOOD	CART	NEAR PANCHMUKHI	BORING CANAL ROAD
195	DHARMENDRA	FRUITS	CART	NEAR PANCHMUKHI	BORING CANAL ROAD
196	PAPPU	FRUITS	CART	NEAR PANCHMUKHI	BORING CANAL ROAD
197	PAPPU KUMAR	FRUITS	CART	NEAR PANCHMUKHI	BORING CANAL ROAD
198	RAMBABU SAO	FRUITS	CART	NEAR PANCHMUKHI	BORING CANAL ROAD
199	RAMJI	FRUITS	CART	NEAR PANCHMUKHI	BORING CANAL ROAD
200	RAMU KUMAR	FRUITS	CART	NEAR PANCHMUKHI	BORING CANAL ROAD
201	UMESH SAO	FRUITS	CART	NEAR PANCHMUKHI	BORING CANAL ROAD
202	ASHOK SAO	ICECREAM-CART	CART	NEAR PANCHMUKHI	BORING CANAL ROAD
203	PRADEEP KUMAR	JUICE	CART	NEAR PANCHMUKHI	BORING CANAL ROAD
204	RAHUL PANDEY	JUICE	CART	NEAR PANCHMUKHI	BORING CANAL ROAD
205	JEETU	PAN SHOP	CART	NEAR PANCHMUKHI	BORING CANAL ROAD
206	GULSHAN SHARMA	PAN SHOP	GUMTI	NEAR PANCHMUKHI	BORING CANAL ROAD
207	KRISHNA KISHORE	PAN SHOP	GUMTI	NEAR PANCHMUKHI	BORING CANAL ROAD
208	LALAN KUMAR	PAN SHOP	GUMTI	NEAR PANCHMUKHI	BORING CANAL ROAD
209	DEEPAK KUMAR	SNACKS/BHUNJA	CART	NEAR PANCHMUKHI	BORING CANAL ROAD
210	VIJAY	SNACKS/CHAAT	CART	NEAR PANCHMUKHI	BORING CANAL ROAD
211	SIKANDAR	SNACKS/LITTI	CART	NEAR PANCHMUKHI	BORING CANAL ROAD
212	MANISH	SNACKS/MOMO	CART	NEAR PANCHMUKHI	BORING CANAL ROAD
213	ANIL KUMAR	SNACKS-GOLGAPPA	CART	NEAR PANCHMUKHI	BORING CANAL ROAD
214	RAJ KUMAR	SNACKS-GOLGAPPA	CART	NEAR PANCHMUKHI	BORING CANAL ROAD
215	UPINDER	SNACKS-GOLGAPPA	CART	NEAR PANCHMUKHI	BORING CANAL ROAD
216	AMIT KUMAR	TEA SHOP	CART	NEAR PANCHMUKHI	BORING CANAL ROAD
217	RAJESH KUMAR	TEA SHOP	CART	NEAR PANCHMUKHI	BORING CANAL ROAD
218	REKHA DEVI	TEA SHOP	CART	NEAR PANCHMUKHI	BORING CANAL ROAD
219	SANJAY KANT	TEA SHOP	CART	NEAR PANCHMUKHI	BORING CANAL ROAD
220	NAND BHARAT	VEGETABLES	CART	NEAR PANCHMUKHI	BORING CANAL ROAD
221	JOGINDER PRASAD	VEGETABLES	ON FLOOR/CART	NEAR PANCHMUKHI	BORING CANAL ROAD
222	RAJ KUMAR	VEGETABLES	ON FLOOR/CART	NEAR PANCHMUKHI	BORING CANAL ROAD
223	SANTOSH KUMAR	VEGETABLES	ON FLOOR/CART	NEAR PANCHMUKHI	BORING CANAL ROAD
224	MD. ASGAR ALI	WELDING	CART	NEAR PANCHMUKHI	BORING CANAL ROAD
225	BHUNESAR RAM	COBBLER	ON FLOOR	NEAR PANT BHAWAN	BORING CANAL ROAD



S#	NAME	SELLING ITEM	VENDING MODE	AREA	LOCATION
226	BUDDHAN RAM	COBBLER	ON FLOOR	NEAR PANT BHAWAN	BORING CANAL ROAD
227	RAJ KUMAR	FRUITS	CART	NEAR PANT BHAWAN	BORING CANAL ROAD
228	KRISHNA KUMAR	JUICE	CART	NEAR PANT BHAWAN	BORING CANAL ROAD
229	RAJU KUMAR	JUICE	CART	NEAR PANT BHAWAN	BORING CANAL ROAD
230	RAMESH	JUICE	CART	NEAR PANT BHAWAN	BORING CANAL ROAD
231	RAVI KUMAR	MOBILE COVER	TABLE	NEAR PANT BHAWAN	BORING CANAL ROAD
232	BIJENDRA ROY	PAN SHOP	GUMTI	NEAR PANT BHAWAN	BORING CANAL ROAD
233	MAHESH ROY	PAN SHOP	GUMTI	NEAR PANT BHAWAN	BORING CANAL ROAD
234	MANOJ KUMAR	PAN SHOP	GUMTI	NEAR PANT BHAWAN	BORING CANAL ROAD
235	RAAM SAH	SNACK-SATTU	CART	NEAR PANT BHAWAN	BORING CANAL ROAD
236	SHANKAR MANDAL	SNACKS-EGG	CART	NEAR PANT BHAWAN	BORING CANAL ROAD
237	RAVINDRA ROY	SODA - JUICE	VAN	NEAR PANT BHAWAN	BORING CANAL ROAD
238	DHARAMVEER ROY	TEA SHOP	CART	NEAR PANT BHAWAN	BORING CANAL ROAD
239	DHARMENDRA RAM	TEA SHOP	CART	NEAR PANT BHAWAN	BORING CANAL ROAD
240	RAJ KUMAR GUPTA	TEA SHOP	CART	NEAR PANT BHAWAN	BORING CANAL ROAD
241	SANJAY DAS	TEA SHOP	CART	NEAR PANT BHAWAN	BORING CANAL ROAD
242	SONU KUMAR	TEA SHOP	CART	NEAR PANT BHAWAN	BORING CANAL ROAD
243	BIJENDRA MISTRI	TEA-SNACKS	CART	NEAR PANT BHAWAN	BORING CANAL ROAD
244	VIRENDRA RAHIAT	CLOTH IRON	CART	NEAR PESHAWARI-PARKING	BORING CANAL ROAD
245	UMESH KUMAR	JUICE-SUGAN CANE	CART	NEAR PESHAWARI-PARKING	BORING CANAL ROAD
246	BIPIN PD	PAN SHOP	CART	NEAR PESHAWARI-PARKING	BORING CANAL ROAD
247	SUDISH PATEL	PAN SHOP	CART	NEAR PESHAWARI-PARKING	BORING CANAL ROAD
248	SUDHIR KUMAR	SNACKS-BHUNJA	CART	NEAR PESHAWARI-PARKING	BORING CANAL ROAD
249	MANJIT	SNACKS-GOLGAPPA	CART	NEAR PESHAWARI-PARKING	BORING CANAL ROAD
250	ROHIT KUMAR	SNACKS-GOLGAPPA	CART	NEAR PESHAWARI-PARKING	BORING CANAL ROAD
251	LALBABU	TEA SHOP	CART	NEAR PESHAWARI-PARKING	BORING CANAL ROAD
252	RAMJI SINGH	TEA SHOP	CART	NEAR PESHAWARI-PARKING	BORING CANAL ROAD
253	KRISHNA PATEL	TEA SHOP	TABLE	NEAR PESHAWARI-PARKING	BORING CANAL ROAD
254	SHAMBHU KUMAR	FRUITS	CART	NEAR PESHAWARI-PARKING	BORING CANAL ROAD
255	HIRA KUMAR	FRUITS	CART	NEAR RAHUL ART PRINTING	BORING CANAL ROAD
256	MANISH KUMAR	FRUITS	CART	NEAR RAJAPUL JAL PARSHAD	BORING CANAL ROAD, RAJAPUL
257	MUKESH KUMAR	FRUITS	CART	NEAR RAJAPUL JAL PARSHAD	BORING CANAL ROAD, RAJAPUL
258	BHUSHAN TANTI	ICECREAM-CART	CART	NEAR RAJAPUL JAL PARSHAD	BORING CANAL ROAD, RAJAPUL
259	VINDHYACHAL SAO	SNACKS/BHUNJA	CART	NEAR RAJAPUL JAL PARSHAD	BORING CANAL ROAD, RAJAPUL
260	BIHARI PASWAN	SNACKS/MOMO	CART	NEAR RAJAPUL JAL PARSHAD	BORING CANAL ROAD, RAJAPUL
261	CHINTA DEVI	VEGETABLES	ONFLOOR/CART	NEAR RAJAPUL JAL PARSHAD	BORING CANAL ROAD, RAJAPUL
262	HEMANT MAHTO	VEGETABLES	ONFLOOR/CART	NEAR RAJAPUL JAL PARSHAD	BORING CANAL ROAD, RAJAPUL
263	KANTI DEVI	VEGETABLES	ONFLOOR/CART	NEAR RAJAPUL JAL PARSHAD	BORING CANAL ROAD, RAJAPUL
264	MUNNI DEVI	VEGETABLES	ONFLOOR/CART	NEAR RAJAPUL JAL PARSHAD	BORING CANAL ROAD, RAJAPUL
265	RAHUL KUMAR	VEGETABLES	ONFLOOR/CART	NEAR RAJAPUL JAL PARSHAD	BORING CANAL ROAD, RAJAPUL
266	RAJKUMAR MAHTO	VEGETABLES	ONFLOOR/CART	NEAR RAJAPUL JAL PARSHAD	BORING CANAL ROAD, RAJAPUL
267	RAMESH SAO	VEGETABLES	ONFLOOR/CART	NEAR RAJAPUL JAL PARSHAD	BORING CANAL ROAD, RAJAPUL
268	RUNICHA DEVI	VEGETABLES	ONFLOOR/CART	NEAR RAJAPUL JAL PARSHAD	BORING CANAL ROAD, RAJAPUL
269	SAKALDEEP MAHTO	VEGETABLES	ONFLOOR/CART	NEAR RAJAPUL JAL PARSHAD	BORING CANAL ROAD, RAJAPUL
270	SAKEENA KHATUN	VEGETABLES	ONFLOOR/CART	NEAR RAJAPUL JAL PARSHAD	BORING CANAL ROAD, RAJAPUL

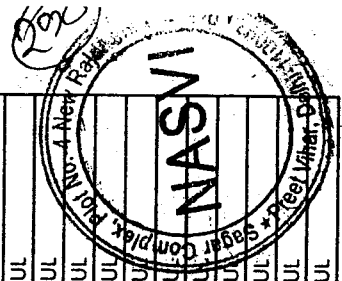

S#	NAME	SELLING ITEM	VENDEING MODE	AREA	LOCATION
271	SUDAMA MAHTO	VEGETABLES	ON FLOOR/CART	NEAR RAJAPUL JAL PARSHAD	BORING CANAL ROAD, RAJAPUL
272	SUNIL KUMAR GUPTA	VEGETABLES	ON FLOOR/CART	NEAR RAJAPUL JAL PARSHAD	BORING CANAL ROAD, RAJAPUL
273	VINOD MAHTO	VEGETABLES	ON FLOOR/CART	NEAR RAJAPUL JAL PARSHAD	BORING CANAL ROAD, RAJAPUL
274	GIRDHARI (RAVI KUMAR SINGH)	COBBLER	ON FLOOR	NEAR RAJAPUL KFC	BORING CANAL ROAD, RAJAPUL
275	PREM KUMAR	COBBLER	ON FLOOR	NEAR RAJAPUL KFC	BORING CANAL ROAD, RAJAPUL
276	JITENDRA PRASAD	PAN SHOP	CART	NEAR RAJAPUL KFC	BORING CANAL ROAD, RAJAPUL
277	HEMA DEVI	SNACKS-EGG	CART	NEAR RAJAPUL KFC	BORING CANAL ROAD, RAJAPUL
278	RAMSAKIL KUMAR YADAV	SNACKS-EGG	CART	NEAR RAJAPUL KFC	BORING CANAL ROAD, RAJAPUL
279	KANCHAN KUMAR	SNACKS-GOLGAPPA	CART	NEAR RAJAPUL KFC	BORING CANAL ROAD, RAJAPUL
280	SURESH PASWAN	TEA SHOP	CART	NEAR RAJAPUL KFC	BORING CANAL ROAD, RAJAPUL
281	AMAR NATH	VEGETABLES	ON FLOOR/CART	NEAR RAJAPUL MAX HT	BORING CANAL ROAD, RAJAPUL
282	ARVIND KUMAR SAH	VEGETABLES	ON FLOOR/CART	NEAR RAJAPUL MAX HT	BORING CANAL ROAD, RAJAPUL
283	INDU DEVI	VEGETABLES	ON FLOOR/CART	NEAR RAJAPUL MAX HT	BORING CANAL ROAD, RAJAPUL
284	MALTI DEVI	VEGETABLES	ON FLOOR/CART	NEAR RAJAPUL MAX HT	BORING CANAL ROAD, RAJAPUL
285	RAJ GUPTA	VEGETABLES	ON FLOOR/CART	NEAR RAJAPUL MAX HT	BORING CANAL ROAD, RAJAPUL
286	SATENDAR SINGH	VEGETABLES	ON FLOOR/CART	NEAR RAJAPUL MAX HT	BORING CANAL ROAD, RAJAPUL
287	SWEETY DEVI	VEGETABLES	ON FLOOR/CART	NEAR RAJAPUL MAX HT	BORING CANAL ROAD, RAJAPUL
288	PREM KUMAR GUPTA	DATMAN SHOP	TOKRI	NEAR RAJAPUL MORE	BORING CANAL ROAD, RAJAPUL
289	MAHESH KUMAR	KEY SHOP	ON FLOOR	NEAR RAJAPUL MORE	BORING CANAL ROAD, RAJAPUL
290	MD. RAFI	KEY SHOP	ON FLOOR	NEAR RAJAPUL MORE	BORING CANAL ROAD, RAJAPUL
291	VINOD KUMAR SAINI	PAN SHOP	GUMTI	NEAR RAJAPUL MORE	BORING CANAL ROAD, RAJAPUL
292	GAURISHANKAR	VEGETABLES	ON FLOOR/CART	NEAR RAJAPUL MORE	BORING CANAL ROAD, RAJAPUL
293	SAVITA DEVI	VEGETABLES	ON FLOOR/CART	NEAR RAJAPUL MORE	BORING CANAL ROAD, RAJAPUL
294	RAVI PRAKASH	CLOTHES	CART	NEAR RAJAPUL PANTALOONS	BORING CANAL ROAD, RAJAPUL
295	AVDESH KUMAR	FRUITS	CART	NEAR RAJAPUL PANTALOONS	BORING CANAL ROAD, RAJAPUL
296	DEVENDRA KUMAR	FRUITS	CART	NEAR RAJAPUL PANTALOONS	BORING CANAL ROAD, RAJAPUL
297	DILEEP KUMAR	FRUITS	CART	NEAR RAJAPUL PANTALOONS	BORING CANAL ROAD, RAJAPUL
298	PRAMOD KUMAR	RECHARGE SHOP	TABLE	NEAR RAJAPUL PANTALOONS	BORING CANAL ROAD, RAJAPUL
299	RAMESH KUMAR	SNACKS/BHUNJA	CART	NEAR RAJAPUL PANTALOONS	BORING CANAL ROAD, RAJAPUL
300	DHARMENDRA KUMAR	TOKRI	ON FLOOR	NEAR RAJAPUL PANTALOONS	BORING CANAL ROAD, RAJAPUL
301	GULABI DEVI	VEGETABLES	ON FLOOR/CART	NEAR RAJAPUL PANTALOONS	BORING CANAL ROAD, RAJAPUL
302	SUBADRA LAL YADAV	VEGETABLES	ON FLOOR/CART	NEAR RAJAPUL PANTALOONS	BORING CANAL ROAD, RAJAPUL
303	AMIT DAS	FRUITS	CART	NEAR RAJAPUL SUMP HOUSE	BORING CANAL ROAD, RAJAPUL
304	GUDDU KUMAR	FRUITS	CART	NEAR RAJAPUL SUMP HOUSE	BORING CANAL ROAD, RAJAPUL
305	SONU KUMAR SINGH	FRUITS	CART	NEAR RAJAPUL SUMP HOUSE	BORING CANAL ROAD, RAJAPUL
306	ASHOK KUMAR GUPTA	VEGETABLES	ON FLOOR/CART	NEAR RAJAPUL SUMP HOUSE	BORING CANAL ROAD, RAJAPUL
307	GOLU KUMAR	VEGETABLES	ON FLOOR/CART	NEAR RAJAPUL SUMP HOUSE	BORING CANAL ROAD, RAJAPUL
308	LAL BABU	VEGETABLES	ON FLOOR/CART	NEAR RAJAPUL SUMP HOUSE	BORING CANAL ROAD, RAJAPUL
309	LAXMAN GUPTA	VEGETABLES	ON FLOOR/CART	NEAR RAJAPUL SUMP HOUSE	BORING CANAL ROAD, RAJAPUL
310	LAXMAN SAH	VEGETABLES	ON FLOOR/CART	NEAR RAJAPUL SUMP HOUSE	BORING CANAL ROAD, RAJAPUL
311	RAJEEV SAH	VEGETABLES	ON FLOOR/CART	NEAR RAJAPUL SUMP HOUSE	BORING CANAL ROAD, RAJAPUL
312	SADHU MAHTO	VEGETABLES	ON FLOOR/CART	NEAR RAJAPUL SUMP HOUSE	BORING CANAL ROAD, RAJAPUL
313	SAGAR SAH	VEGETABLES	ON FLOOR/CART	NEAR RAJAPUL SUMP HOUSE	BORING CANAL ROAD, RAJAPUL
314	SAJEET MAHTO	VEGETABLES	ON FLOOR/CART	NEAR RAJAPUL SUMP HOUSE	BORING CANAL ROAD, RAJAPUL
315	SHEELA DEVI	VEGETABLES	ON FLOOR/CART	NEAR RAJAPUL SUMP HOUSE	BORING CANAL ROAD, RAJAPUL

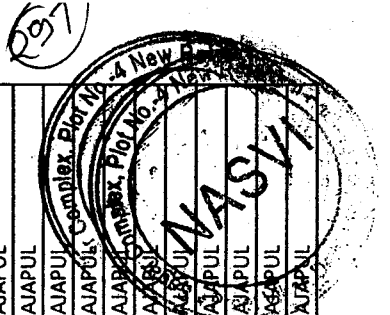

MAHESH

#	NAME	SELLING ITEM	VENDING MODE	AREA	LOCATION
316	SUNITA DEVI	VEGETABLES	ONFLOOR/CART	NEAR RAJAPUL SUMP HOUSE	BORING CANAL ROAD, RAJAPUL
317	URMILA DEVI	VEGETABLES	ONFLOOR/CART	NEAR RAJAPUL SUMP HOUSE	BORING CANAL ROAD, RAJAPUL
318	VIJAY SAH	VEGETABLES	ONFLOOR/CART	NEAR RAJAPUL SUMP HOUSE	BORING CANAL ROAD, RAJAPUL
319	KRISHNA SAO	VEGETABLES	CART	NEAR SABZI MANDI	BORING CANAL ROAD
320	UMA SHANKAR	VEGETABLES	CART	NEAR SABZI MANDI	BORING CANAL ROAD
321	DILEEP NARESHWANI	VEGETABLES	ONFLOOR/CART	NEAR SABZI MANDI	BORING CANAL ROAD
322	LAKSHMAN SAO	VEGETABLES	ONFLOOR/CART	NEAR SABZI MANDI	BORING CANAL ROAD
323	LALA CHAUHAN	VEGETABLES	ONFLOOR/CART	NEAR SABZI MANDI	BORING CANAL ROAD
324	MUNNA KUMAR	VEGETABLES	ONFLOOR/CART	NEAR SABZI MANDI	BORING CANAL ROAD
325	RAMU PANDIT	VEGETABLES	ONFLOOR/CART	NEAR SABZI MANDI	BORING CANAL ROAD
326	VIJAY KUMAR	VEGETABLES	ONFLOOR/CART	NEAR SABZI MANDI	BORING CANAL ROAD
327	ZAFAR	BIKE REPAIR	TABLE	NEAR SENCO, TITAN EYE	BORING CANAL ROAD
328	RAJU KUMAR	FASTFOOD	CART	NEAR SENCO, TITAN EYE	BORING CANAL ROAD
329	HARENDRA KUMAR	SNACKS/LITTI	CART	NEAR SENCO, TITAN EYE	BORING CANAL ROAD
330	PANKAJ KUMAR	SNACKS-MOMO	CART-MOBILE	NEAR SENCO, TITAN EYE	BORING CANAL ROAD
331	DHANANJAY	VEGETABLES	CART	NEAR SENCO, TITAN EYE	BORING CANAL ROAD
332	KANTI DEVI	FRUITS	CART	NEAR SHYAMA BHAWAN	BORING CANAL ROAD
333	RAJU KUMAR	FRUITS	CART	NEAR SHYAMA BHAWAN	BORING CANAL ROAD
334	RAMA DEVI	FRUITS	CART	NEAR SHYAMA BHAWAN	BORING CANAL ROAD
335	JAYRAM YADAV	VEGETABLES	ONFLOOR/CART	NEAR SHYAMA BHAWAN	BORING CANAL ROAD
336	ASHOK KUMAR	PAN SHOP	GUMTI	NEAR SISODIA COMPLEX	BORING CANAL ROAD
337	RAKESH KUMAR	SNACKS-SATTU	CART	NEAR SISODIA COMPLEX	BORING CANAL ROAD
338	AMAN AGRAWAL	SNACKS-VADAPAW	STALL	NEAR SISODIA COMPLEX	BORING CANAL ROAD
339	ANUJ KUMAR	FRUITS	CART	NEAR TATA MOTORS	BORING CANAL ROAD
340	SHOP CLOSED DURING SURVEY	FRUITS	CART	NEAR TATA MOTORS	BORING CANAL ROAD
341	SUSHIL KUMAR	FRUITS	CART	NEAR TATA MOTORS	BORING CANAL ROAD
342	DEEPAK KUMAR	JUICE/ SODA	VAN	NEAR TATA MOTORS	BORING CANAL ROAD
343	URMILA DEVI	SHRINGAR	CART	NEAR TATA MOTORS	BORING CANAL ROAD
344	PANKAJ KUMAR	SNACKS/LITTI	CART	NEAR TATA MOTORS	BORING CANAL ROAD
345	ANKIT KUMAR	SNACKS/MOMO	CART	NEAR TATA MOTORS	BORING CANAL ROAD
346	MUKESH KUMAR	SNACKS-GOLGAPPA	CART	NEAR TATA MOTORS	BORING CANAL ROAD
347	CHHOTU KUMAR	FRUITS	CART	NEAR TATA MOTORS	BORING CANAL ROAD
348	MANTU RAM	VEGETABLES	CART	NEAR UDAYAN HOSPITAL	BORING CANAL ROAD
349	RAJU	VEGETABLES	ONFLOOR/CART	NEAR UDAYAN HOSPITAL	BORING CANAL ROAD
350	RAVI PASWAN	VEGETABLES	ONFLOOR/CART	NEAR UDAYAN HOSPITAL	BORING CANAL ROAD
351	RAMANUJ	PAN SHOP	GUMTI	NEAR UDAYAN HOSPITAL	BORING CANAL ROAD
352	BABLU KUMAR	SNACKS/BURGER	CART	NEAR VAN HEUSEN	BORING CANAL ROAD
353	SHAMBHU SAO	SNACKS-GOLGAPPA	CART	NEAR VAN HEUSEN	BORING CANAL ROAD
354	ANIL RAJAK	CLOTH IRON	CART	NEAR VANHUSSAIN	BORING CANAL ROAD
355	GAJENDRA KUMAR	FRUITS	CART	NEAR VANHUSSAIN	BORING CANAL ROAD
356	SANJAY RAVI	FRUITS	CART	NEAR VANHUSSAIN	BORING CANAL ROAD
357	AJAY CHAURASIYA	PAN SHOP	CART	NEAR VANHUSSAIN	BORING CANAL ROAD
358	MITHILESH KUMAR	FASTFOOD	STALL/CART	NEAR VISHNU PALACE	BORING CANAL ROAD
359	KUMAR GAURAV	LISSI	STALL	NEAR WARD OFFICE	BORING CANAL ROAD
360	AJMERI KHATOON	FRUITS	STALL	NEAR WARD OFFICE	BORING CANAL ROAD
				NEAR WARD OFFICE, BEHIND SUDHA BOOTH	BORING CANAL ROAD

236



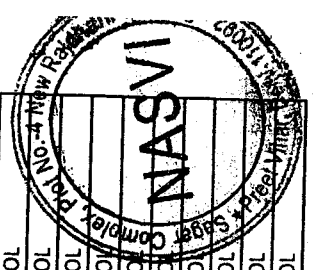

S#	NAME	SELLING ITEM	VENDING MODE	AREA	LOCATION
361	BABLU SAW	FRUITS	STALL	NEAR WARD OFFICE, BEHIND SUDHA BOOTH	BORING CANAL ROAD
362	BACHACHAN KUMAR	FRUITS	STALL	NEAR WARD OFFICE, BEHIND SUDHA BOOTH	BORING CANAL ROAD
363	HARISHANKAR KUMAR	FRUITS	STALL	NEAR WARD OFFICE, BEHIND SUDHA BOOTH	BORING CANAL ROAD
364	MANOJ KUMAR	FRUITS	STALL	NEAR WARD OFFICE, BEHIND SUDHA BOOTH	BORING CANAL ROAD
365	RAJU SINGH	FRUITS	STALL	NEAR WARD OFFICE, BEHIND SUDHA BOOTH	BORING CANAL ROAD
366	RANJIT KUMAR	FRUITS	STALL	NEAR WARD OFFICE, BEHIND SUDHA BOOTH	BORING CANAL ROAD
367	REYAZ ANSAR	FRUITS	STALL	NEAR WARD OFFICE, BEHIND SUDHA BOOTH	BORING CANAL ROAD
368	SANJIT KUMAR	FRUITS	STALL	NEAR WARD OFFICE, BEHIND SUDHA BOOTH	BORING CANAL ROAD
369	VIJAY KUMAR	FRUITS	STALL	NEAR WARD OFFICE, BEHIND SUDHA BOOTH	BORING CANAL ROAD
370	RAUSHAN KUMAR	PAN SHOP	STALL	NEAR WARD OFFICE, BEHIND SUDHA BOOTH	BORING CANAL ROAD
371	AMINA KHATOON	PAN SHOP	GUMTI	NEAR WARD OFFICE, BEHIND SUDHA BOOTH	BORING CANAL ROAD
372	CHHATTHI LAL	SNACKS	PAN STALL	NEAR WARD OFFICE, BEHIND SUDHA BOOTH	BORING CANAL ROAD
373	DILIP KUMAR	SNACKS-EGG	GUMTI	NEAR WARD OFFICE, BEHIND SUDHA BOOTH	BORING CANAL ROAD
374	KEDAR PD	SNACKS-LITTI	CART	NEAR WARD OFFICE, BEHIND SUDHA BOOTH	BORING CANAL ROAD
375	BHIM KUMAR	TEA SHOP	CART	NEAR WARD OFFICE, BEHIND SUDHA BOOTH	BORING CANAL ROAD
376	JITENDRA KUMAR	TEA SHOP	CART	NEAR WARD OFFICE, BEHIND SUDHA BOOTH	BORING CANAL ROAD
377	NAGENDRA KUMAR	TEA SHOP	CART	NEAR WARD OFFICE, BEHIND SUDHA BOOTH	BORING CANAL ROAD
378	PRADEEP KUMAR	TEA SHOP	CART	NEAR WARD OFFICE, BEHIND SUDHA BOOTH	BORING CANAL ROAD
379	KRISHNA PD GUPTA	TEA SHOP	CART	NEAR WARD OFFICE, BEHIND SUDHA BOOTH	BORING CANAL ROAD
380	RAVI PRAKASH	VEGETABLES	STALL	NEAR WARD OFFICE, BEHIND SUDHA BOOTH	BORING CANAL ROAD
381	JAMUN SAH	FRUITS	CART	NEAR WARD OFFICE, BEHIND SUDHA BOOTH	BORING CANAL ROAD
382	GOLU KUMAR	VEGETABLES	CART	OPPOSITE HDFC BANK	BORING CANAL ROAD, RAJAPUL
383	HARIRAM	FRUITS	CART	OPPOSITE HDFC BANK	BORING CANAL ROAD, RAJAPUL
384	RASHID AHMAD	FRUITS	RAJAPUL-MANDI-ON FLOOR	RAJAPUL-MANDI	BORING CANAL ROAD RAJAPUL
385	SUNIL KUMAR	FRUITS	RAJAPUL-MANDI-ON FLOOR	RAJAPUL-MANDI	BORING CANAL ROAD RAJAPUL
386	ANURAG KUMAR URF GUDDU	FRUITS	RAJAPUL-MANDI-ON FLOOR	RAJAPUL-MANDI	BORING CANAL ROAD RAJAPUL
387	BABY DEVI	VEGETABLES	RAJAPUL-MANDI-ON FLOOR	RAJAPUL-MANDI	BORING CANAL ROAD RAJAPUL
388	BAJUNATH SAO	VEGETABLES	RAJAPUL-MANDI-ON FLOOR	RAJAPUL-MANDI	BORING CANAL ROAD RAJAPUL
389	BANKE BIHARI	VEGETABLES	RAJAPUL-MANDI-ON FLOOR	RAJAPUL-MANDI	BORING CANAL ROAD RAJAPUL
390	BISUNI DEVI	VEGETABLES	RAJAPUL-MANDI-ON FLOOR	RAJAPUL-MANDI	BORING CANAL ROAD RAJAPUL
391	CHANDAN KUMAR	VEGETABLES	RAJAPUL-MANDI-ON FLOOR	RAJAPUL-MANDI	BORING CANAL ROAD RAJAPUL
392	DEVSHARAN PD	VEGETABLES	RAJAPUL-MANDI-ON FLOOR	RAJAPUL-MANDI	BORING CANAL ROAD RAJAPUL
393	DINANATH PD	VEGETABLES	RAJAPUL-MANDI-ON FLOOR	RAJAPUL-MANDI	BORING CANAL ROAD RAJAPUL
394	GIRISH SINGH	VEGETABLES	RAJAPUL-MANDI-ON FLOOR	RAJAPUL-MANDI	BORING CANAL ROAD RAJAPUL
395	GUDDU KUMAR	VEGETABLES	RAJAPUL-MANDI-ON FLOOR	RAJAPUL-MANDI	BORING CANAL ROAD RAJAPUL
396	JAYKISHUN CHAUHAN	VEGETABLES	RAJAPUL-MANDI-ON FLOOR	RAJAPUL-MANDI	BORING CANAL ROAD RAJAPUL
397	JIALAL	VEGETABLES	RAJAPUL-MANDI-ON FLOOR	RAJAPUL-MANDI	BORING CANAL ROAD RAJAPUL
398	JIMI KUMAR	VEGETABLES	RAJAPUL-MANDI-ON FLOOR	RAJAPUL-MANDI	BORING CANAL ROAD RAJAPUL
399	KISHORI SINGH	VEGETABLES	RAJAPUL-MANDI-ON FLOOR	RAJAPUL-MANDI	BORING CANAL ROAD RAJAPUL
400	KUNDAN KUMAR	VEGETABLES	RAJAPUL-MANDI-ON FLOOR	RAJAPUL-MANDI	BORING CANAL ROAD RAJAPUL
401	LAKSHMAN RAM	VEGETABLES	RAJAPUL-MANDI-ON FLOOR	RAJAPUL-MANDI	BORING CANAL ROAD RAJAPUL
402	MANISH KUMAR	VEGETABLES	RAJAPUL-MANDI-ON FLOOR	RAJAPUL-MANDI	BORING CANAL ROAD RAJAPUL
403	MANOJ KUMAR	VEGETABLES	RAJAPUL-MANDI-ON FLOOR	RAJAPUL-MANDI	BORING CANAL ROAD RAJAPUL
404	MD IFRAN	VEGETABLES	RAJAPUL-MANDI-ON FLOOR	RAJAPUL-MANDI	BORING CANAL ROAD RAJAPUL
405	MD. ANNU	VEGETABLES	RAJAPUL-MANDI-ON FLOOR	RAJAPUL-MANDI	BORING CANAL ROAD RAJAPUL

